



Introduction



In the beginning.

In 2001, during the construction boom, a niche in the market was recognised by a keen entrepreneur and Handles Inc. was born. Lawrence Koff wanted to change the perception of how big a difference a seemingly small detail, like a door handle can make and offer the best service and product in the market.

From these early beginnings with the original Strand Street store, today we have 6 branches with our headoffice in Bree Street, Cape Town. Future plans to expand into all major cities is on the cards.

Our range and depth is well over 10 000 inventory items with a selection to suit every design and budget. We are the choice supplier and retailer to everyone from the DIY handyman to the top architects, builders and designers in South Africa.

Our offering ranges from handles to door controls and mechanisms, specialised window fittings, custom-made and bespoke ironmongery, bathroom fittings and a host of accessories that serve the industry.

BEST

1

Being the best-in-the-game means we truly have a handle on what we supply; we strive to make sure all products are produced and supplied to meet their price-point.

PRODUCTS

2

Over many years we have cultivated an expertise encompassing a vast array of products – local and international. This allows us to present to you the very best.

SUPPORT

3

They say great customer support is the foundation of every company; but for us it's more than that. Working with you every step of the way is what gets us out of bed in the morning.

Contact details



Cape Town. Head office

165 Bree Street,
Cape Town.
021 422 2322
bree@handlesinc.co.za

Somerset West

Shop 2, 3 Cyclonite Street,
The Interchange Somerset West
021 850 0047
somersetwest@handlesinc.co.za

Tyger Valley

Shop 3 Edward III Building,
70 Edwards Street Tygervalley
021 910 2255
tygervalley@handlesinc.co.za



Lever Handles

lever handles on rose



HANDLES INC
Handle on round rose
Satin brass PVD coated
5 year guarantee

sku: AROGANBRS



HANDLES INC
Handle on round rose
Satin brass PVD coated
5 year guarantee

sku: CH086



HANDLES INC
Handle on round rose
Satin brass PVD coated
5 year guarantee

sku: PELLOBRS



HANDLES INC
Handle on round rose
Satin brass PVD coated
5 year guarantee

sku: CH087



HANDLES INC
Handle on round rose
Brushed stainless steel

sku: CH003



HANDLES INC
Handle on round rose
Brushed stainless steel

sku: CH004



HANDLES INC
Handle on round rose
Satin brass PVD coated
5 year guarantee

sku: CH088



HANDLES INC
Handle on round rose
Brushed stainless steel

sku: CH013



HANDLES INC
Handle on square rose
Brushed stainless steel

sku: CH006



HANDLES INC
Handle on round rose
PVD coated black
5 year guarantee

sku: AROGANBLK

lever handles on rose



HANDLES INC
Handle on round rose
Black

sku: CH012



HANDLES INC
Handle on round rose
PVD coated black
5 year guarantee

sku: PELLOBLK



HANDLES INC
Handle on round rose
Black

sku: CH011



HANDLES INC
Solid knurled handle
on round rose
Black

sku: CH051



HANDLES INC
Knurled handle on
round rose
Satin brass PVD coated
5 year guarantee

sku: CH099



HANDLES INC
Knurled handle on
round rose
Brushed stainless steel

sku: CH097



HANDLES INC
Knurled handle on
round rose
Black

sku: CH098

lever handles on rose



OLIVARI
Handle on round rose
Super gold bright
30 year guarantee

sku: LAMA5



OLIVARI
Handle on round rose
Super gold satin
30 year guarantee

sku: PLANETBTS



OLIVARI
Handle on round rose
Super bronze satin
10 year guarantee

sku: PLANETDS



OLIVARI
Handle on round rose
Super copper satin
10 year guarantee

sku: PLANETRS



OLIVARI
Handle on round rose
Bright chrome
10 year guarantee

sku: LAMA2



OLIVARI
Handle on round rose
Bright chrome
10 year guarantee

sku: LINK2



OLIVARI
Handle on round rose
Bright chrome
10 year guarantee

sku: LOTUS2



OLIVARI
Handle on round rose
Bright chrome
10 year guarantee

sku: MARBELLA3



OLIVARI
Handle on round rose
Bright chrome
10 year guarantee

sku: PLANET5



OLIVARI
Handle on round rose
Bright chrome
10 year guarantee

sku: PLANETBCR

lever handles on rose



OLIVARI
Handle on
concealed rose
Bright chrome
10 year guarantee

sku: RADIAL4



OLIVARI
Handle on round rose
Bright chrome
10 year guarantee

sku: TWIST2



OLIVARI
Handle on round rose
Satin chrome
10 year guarantee

sku: LAMA1



OLIVARI
Handle on round rose
Satin chrome
10 year guarantee

sku: LINK3



OLIVARI
Handle on round rose
Satin chrome
10 year guarantee

sku: LOTUS1



OLIVARI
Handle on round rose
Satin chrome
10 year guarantee

sku: MARBELLA1



OLIVARI
Handle on round rose
Satin chrome
10 year guarantee

sku: PLANET4



OLIVARI
Handle on round rose
Satin chrome
10 year guarantee

sku: PLANET4B



OLIVARI
Handle on
concealed rose
Satin chrome
10 year guarantee

sku: RADIAL2



OLIVARI
Handle on round rose
Super satin nickel
30 year guarantee

sku: PLANETBNS

lever handles on rose



OLIVARI
Handle on round rose
Super inox satin
30 year guarantee

sku: LAMA3



OLIVARI
Handle on round rose
Super inox satin
30 year guarantee

sku: LINK-IS



OLIVARI
Handle on round rose
Super inox satin
30 year guarantee

sku: MARBELLA2



OLIVARI
Handle on round rose
Super inox satin
30 year guarantee

sku: PLANET6



OLIVARI
Handle on round rose
Super anthracite
10 year guarantee

sku: LAMA4



OLIVARI
Handle on round rose
Super anthracite
10 year guarantee

sku: LINKUS



OLIVARI
Handle on round rose
Super anthracite
10 year guarantee

sku: LOTUS3



OLIVARI
Handle on round rose
Super anthracite
10 year guarantee

sku: PLANET12



OLIVARI
Handle on
concealed rose
Super anthracite
10 year guarantee

sku: RADIALUS



OLIVARI
Handle on round rose
Super anthracite
10 year guarantee

sku: TWIST.US

lever handles on rose



OLIVARI

Handle on round rose

Black

10 year guarantee

sku: PLANETBUS

lever handles on rose

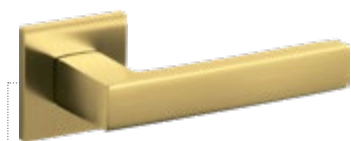

OLIVARI
Handle on square rose
Super gold satin
30 year guarantee

sku: PLANETQBTS



OLIVARI
Handle on square rose
Super bronze satin
10 year guarantee

sku: PLANETQBDS



OLIVARI
Handle on square rose
Bright chrome
10 year guarantee

sku: DIANA2



OLIVARI
Handle on square rose
Bright chrome
10 year guarantee

sku: PLANETQ4



OLIVARI
Handle on square rose
Bright chrome
10 year guarantee

sku: LOTUSQ4



OLIVARI
Handle on
concealed rose
Bright chrome
10 year guarantee

sku: TOTAL2



OLIVARI
Handle on square rose
Bright chrome
10 year guarantee

sku: TREND2



OLIVARI
Handle on square rose
Satin chrome
10 year guarantee

sku: DIANA1



OLIVARI
Handle on square rose
Satin chrome
10 year guarantee

sku: PLANETQ2



OLIVARI
Handle on square rose
Satin chrome
10 year guarantee

sku: LOTUSQ1

lever handles on rose



OLIVARI
Handle on square rose
Satin chrome
10 year guarantee

sku: PLANETQB1



OLIVARI
Handle on concealed rose
Satin chrome
10 year guarantee

sku: TOTAL1



OLIVARI
Handle on square rose
Satin chrome
10 year guarantee

sku: TREND1



OLIVARI
Handle on square rose
Super inox satin
30 year guarantee

sku: DIANA4



OLIVARI
Handle on concealed rose
Super inox satin
30 year guarantee

sku: TOTAL3



OLIVARI
Handle on square rose
Super anthracite
10 year guarantee

sku: DIANA6



OLIVARI
Handle on square rose
Super anthracite
10 year guarantee

sku: LOTUSQ2



OLIVARI
Handle on square rose
Super anthracite
10 year guarantee

sku: PLANETQBUS



OLIVARI
Handle on concealed rose
Super anthracite
10 year guarantee

sku: TOTALUS



OLIVARI
Handle on square rose
Super anthracite
10 year guarantee

sku: TREND4

lever handles on rose



MANDELLI
Handle on round rose
Polished brass

sku: ANDE03



MANDELLI
Handle on round rose
Polished & satin brass

sku: CHI004



MANDELLI
Handle on round rose
Satin brass

sku: ANDE04



MANDELLI
Handle on round rose
Satin brass

sku: BILAS04



MANDELLI
Handle on round rose
Satin brass

sku: ISI04



MANDELLI
Handle on round rose
Satin brass

sku: OLA04T



MANDELLI
Handle on round rose
Satin brass

sku: SPIN04



MANDELLI
Handle on round rose
Polished & satin brass

sku: ZEN2



MANDELLI
Handle on round rose
Bronze

sku: SEVILLE



MANDELLI
Handle on round rose
Polished chrome

sku: ANDE

lever handles on rose



MANDELLI
Handle on round rose
Polished chrome

sku: KIRI26



MANDELLI
Handle on round rose
Polished chrome

sku: SPIN26



MANDELLI
Handle on round rose
Satin chrome

sku: ANDE26D



MANDELLI
Handle on round rose
Satin chrome

sku: LINK26D



MANDELLI
Handle on round rose
Satin chrome

sku: MITOS26D



MANDELLI
Handle on round rose
Satin chrome

sku: OLA26D



MANDELLI
Handle on round rose
Satin chrome

sku: SPIN26D



MANDELLI
Handle on round rose
Satin nickel

sku: ISIMSN



MANDELLI
Handle on round rose
Satin nickel

sku: OLAMSN



MANDELLI
Handle on round rose
Antique silver

sku: GOU28

lever handles on rose



MANDELLI
Handle on round rose
Antique silver

sku: SEVILLE3



MANDELLI
Handle on round rose
Black

sku: SEVILLE5

lever handles on rose



MANDELLI

Handle on square rose
Polished chrome

sku: FAN26



MANDELLI

Handle on square rose
Polished chrome

sku: TELIS26



MANDELLI

Handle on square rose
Satin chrome

sku: FAN26D



MANDELLI

Handle on square rose
Satin chrome

sku: LARIO26D



MANDELLI

Handle on square rose
Satin chrome

sku: NURIA26D



MANDELLI

Handle on square rose
Satin chrome

sku: PYRAMID26D



MANDELLI

Handle on square rose
Satin chrome

sku: TELIS



MANDELLI

Handle on square rose
Satin nickel

sku: LINKSQMSN



MANDELLI

Handle on square rose
Black

sku: LARIO-MB

lever handles on rose



ORO & ORO
Handle on round rose
Polished chrome

sku: 06516CP



ORO & ORO
Handle on round rose
Polished chrome

sku: 07116CP



ORO & ORO
Handle on round rose
Matt satin nickel

sku: 06516SN



ORO & ORO
Handle on round rose
Matt satin nickel

sku: 07116SN



ORO & ORO
Handle on round rose
Titanium

sku: 06516TI



ORO & ORO
Handle on round rose
Titanium

sku: 07116TI



ORO & ORO
Handle on round rose
Black

sku: 06516BLK

lever handles on rose



ORO & ORO
Handle on square rose
PVD coated gold

sku: 07215PVDG



ORO & ORO
Handle on square rose
PVD coated gold

sku: 10615GP



ORO & ORO
Handle on square rose
PVD coated gold

sku: 10815PVDG



ORO & ORO
Handle on square rose
Polished chrome

sku: 07215CP



ORO & ORO
Handle on square rose
Polished chrome

sku: 10615CP



ORO & ORO
Handle on square rose
Polished chrome

sku: 10815CP



ORO & ORO
Handle on square rose
Polished chrome

sku: 06515CP



ORO & ORO
Handle on square rose
Satin chrome

sku: 10615SC



ORO & ORO
Handle on square rose
Matt satin nickel

sku: 07215SN



ORO & ORO
Handle on square rose
Matt satin nickel

sku: 10615SN

lever handles on rose



ORO & ORO
Handle on square rose
Matt satin nickel

sku: 10815SN



ORO & ORO
Handle on square rose
Matt satin nickel

sku: 06515SN



ORO & ORO
Handle on square rose
Titanium

sku: 07215TI



ORO & ORO
Handle on square rose
Titanium

sku: 10615TI



ORO & ORO
Handle on square rose
Titanium

sku: 10815TI



ORO & ORO
Handle on square rose
Titanium

sku: 06515TI



ORO & ORO
Handle on square rose
Black

sku: 10615BLK



ORO & ORO
Handle on square rose
Black

sku: 06515BLK

lever handles on rose



FROSIO
Handle on round rose
Polished chrome

sku: CORNER1



FROSIO
Handle on round rose
Polished chrome

sku: INNOVA2



FROSIO
Handle on round rose
Satin chrome

sku: CORNER2



FROSIO
Handle on round rose
Satin chrome

sku: INNOVA1



FROSIO
Handle on round rose
Satin nickel

sku: CORNER3



FROSIO
Handle on round rose
Black

sku: INNOVA3



FROSIO
Handle on round rose
Black

sku: GINEVRA1

lever handles on rose



FROSIO
Handle on square rose
Polished chrome

sku: CORNER4



FROSIO
Handle on square rose
Polished chrome

sku: INNOVA5



FROSIO
Handle on square rose
Polished chrome

sku: AST11



FROSIO
Handle on square rose
Polished chrome

sku: PAOLA2



FROSIO
Handle on square rose
Satin chrome

sku: CORNER5



FROSIO
Handle on square rose
Satin chrome

sku: INNOVA4



FROSIO
Handle on square rose
Satin chrome

sku: AST12



FROSIO
Handle on square rose
Satin chrome

sku: PAOLA1



FROSIO
Handle on square rose
Satin nickel

sku: CORNER6



FROSIO
Handle on square rose
Black

sku: AST15

lever handles on rose



FROSIO
Handle on square rose
Black

sku: INNOVA6



FROSIO
Handle on square rose
Black

sku: PAOLA3

lever handles on rose



GROEL
Handle on round rose
Satin brass

sku: FEY-SB



GROEL
Handle on round rose
Satin chrome

sku: FEY-SC



GROEL
Handle on round rose
Inox tech

sku: TENDENZA-IX



GROEL
Handle on round rose
Graphite tech

sku: TENDENZA-GT



GROEL
Handle on square rose
Inox tech

sku: LOGGIC-IX



GROEL
Handle on square rose
Black

sku: LOGGIC-BLK

lever handles on backplate



HANDLES INC
Knob on backplate
Solid brass
Available blank or with
keyhole/cylinder cutout

sku: 7025



HANDLES INC
Handle on backplate
Solid brass
Available blank or with
keyhole/cylinder cutout

sku: 7026



HANDLES INC
Handle on backplate
Polished brass
Available blank or with
keyhole/cylinder cutout

sku: 1041



HANDLES INC
Handle on backplate
Satin brass
Available blank or with
keyhole/cylinder cutout

sku: 1013



HANDLES INC
Handle on backplate
Satin brass
Available blank or with
keyhole/cylinder cutout

sku: 1035



HANDLES INC
Handle on backplate
Porcelain,
polished brass
Available blank or with
keyhole/cylinder cutout

sku: 1027



HANDLES INC
Handle on backplate
Antique brass
Available blank or with
keyhole/cylinder cutout

sku: 1019



HANDLES INC
Handle on backplate
Polished chrome
Available blank or with
keyhole/cylinder cutout

sku: 1017

lever handles on backplate



HANDLES INC

Handle on backplate

Satin chrome

Available blank or with
keyhole/cylinder cutout

sku: 1015



HANDLES INC

Handle on backplate

Porcelain, satin chrome

Available blank or with
keyhole/cylinder cutout

sku: 1031



HANDLES INC

Handle on backplate

Antique silver

Available blank or with
keyhole/cylinder cutout

sku: 1025



HANDLES INC

Handle on backplate

Porcelain, black

Available blank or with
keyhole/cylinder cutout

sku: 1010



HANDLES INC

Handle on backplate

Black

Available blank or with
keyhole/cylinder cutout

sku: 1008

lever handles on backplate



MANDELLI
Handle on backplate
Polished brass
Available blank or with
keyhole/cylinder cutout

sku: HARTUPLT1



MANDELLI
Handle on backplate
Polished brass
Available blank or with
keyhole/cylinder cutout

sku: ROND01



MANDELLI
Handle on backplate
Satin brass
Available blank or with
keyhole/cylinder cutout

sku: CASTIGLIA5



MANDELLI
Handle on backplate
Satin brass
Available blank or with
keyhole/cylinder cutout

sku: S90PLT3



MANDELLI
Handle on backplate
Polished chrome
Available blank or with
keyhole/cylinder cutout

sku: CALLAS26PLT



MANDELLI
Handle on backplate
Satin chrome
Available blank or with
keyhole/cylinder cutout

sku: FANPLT1



MANDELLI
Handle on backplate
Chrome
Available blank or with
keyhole/cylinder cutout

sku: ZOOMPLT26



MANDELLI
Handle on backplate
Satin nickel
Available blank or with
keyhole/cylinder cutout

sku: SPINPLTMSN

lever handles on backplate



MANDELLI

Handle on backplate
Antique silver
Available blank or with
keyhole/cylinder cutout

sku: SEVILLE4



MANDELLI

Handle on backplate
Antique bronze
Available blank or with
keyhole/cylinder cutout

sku: SEVILLE2



MANDELLI

Handle on backplate
Bronze
Available blank or with
keyhole/cylinder cutout

sku: SEVILLEPLTHB



MANDELLI

Handle on backplate
Black
Available blank or with
keyhole/cylinder cutout

sku: CASTIGLIAPLTBLK



MANDELLI

Handle on backplate
Black
Available blank or with
keyhole/cylinder cutout

sku: SEVILLA6

lever handles on backplate



FROSIO
Handle on backplate
Polished chrome
Available blank or with
keyhole/cylinder cutout

sku: ASTI7



FROSIO
Handle on backplate
Satin chrome
Available blank or with
keyhole/cylinder cutout

sku: ASTI4



FROSIO
Handle on backplate
Satin chrome
Available blank or with
keyhole/cylinder cutout

sku: CORNER7



FROSIO
Handle on backplate
Satin nickel
Available blank or with
keyhole/cylinder cutout

sku: LORENA1



FROSIO
Handle on backplate
Black
Available blank or with
keyhole/cylinder cutout

sku: ASTI6



FROSIO
Handle on backplate
Black
Available blank or with
keyhole/cylinder cutout

sku: CORNER8



FROSIO
Handle on backplate
Black
Available blank or with
keyhole/cylinder cutout

sku: LORENA2



Pull & Flush Handles

pull handles



HANDLES INC
Brushed stainless steel
Length: 250 mm
CTC: 225 mm
Sold in pairs

sku: CH009



HANDLES INC
Satin Brass
PVD coated
Length: 250 mm
CTC: 225 mm
Sold in pairs

sku: CH093



HANDLES INC
Black
Length: 250 mm
CTC: 225 mm
Sold in pairs

sku: CH010



HANDLES INC
Brushed stainless steel
Length: 244 mm
CTC: 225 mm
Tube: 19x19 mm
Sold in pairs

sku: CH018



HANDLES INC
Satin Brass
PVD coated
Length: 244 mm
CTC: 225 mm
Tube: 19x19 mm
Sold in pairs

sku: CH091



HANDLES INC
Black
Length: 244 mm
CTC: 225 mm
Tube: 19x19 mm
Sold in pairs

sku: CH150



HANDLES INC
Brushed stainless steel
Length: 319 mm
CTC: 300 mm
Tube: 19x19 mm
Sold in pairs

sku: CH019

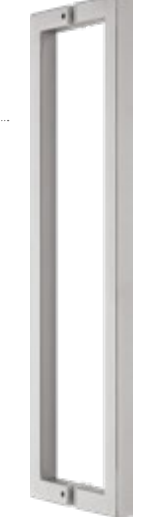

HANDLES INC
Brushed stainless steel
Length: 469 mm
CTC: 450 mm
Tube: 19x19 mm
Sold in pairs

sku: CH020

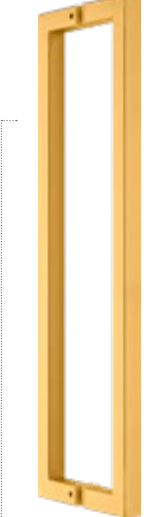

HANDLES INC
Satin Brass
PVD coated
Length: 469 mm
CTC: 450 mm
Tube: 19x19 mm
Sold in pairs

sku: CH092

pull handles



HANDLES INC

Brushed stainless steel
Length: 619 mm
CTC: 600 mm
Tube: 19x19 mm
Sold in pairs

sku: CH021

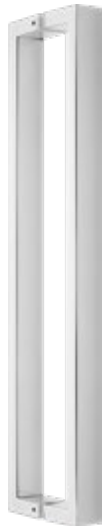

HANDLES INC

Polished stainless steel
Length: 620 mm
CTC: 600 mm
Tube: 40x20 mm
Sold in pairs

sku: CH015



HANDLES INC

Satin Brass PVD coated
Length: 620 mm
CTC: 600 mm
Tube: 40x20 mm
Sold in pairs

sku: CH089



HANDLES INC

Brushed stainless steel
Length: 620 mm
CTC: 600 mm
Tube: 40x20 mm
Sold in pairs

sku: CH014



HANDLES INC

Polished stainless steel
Length: 1220 mm
CTC: 1200 mm
Tube: 40x20 mm
Sold in pairs

sku: CH017



HANDLES INC

Brushed stainless steel
Length: 1220 mm
CTC: 1200 mm
Tube: 40x20 mm
Sold in pairs

sku: CH016



HANDLES INC

T-bar
Brushed stainless steel
Length: 200 mm
CTC: 125 mm
Tube: 22 mm
Sold in pairs

sku: CH056



HANDLES INC

T-bar
Brushed stainless steel
Length: 500 mm
CTC: 350 mm
Tube: 25 mm
Sold in pairs

sku: CH153



HANDLES INC

T-bar
Brushed stainless steel
Length: 500 mm
CTC: 400 mm
Tube: 32 mm
Sold in pairs

sku: CH152

pull handles



HANDLES INC

T-bar

Brushed stainless steel
Length: 1000 mm
CTC: 775 mm
Tube: 32 mm
Sold in pairs

sku: CH151



HANDLES INC

Square mitred

Brushed stainless steel
Length: 600 mm
CTC: 575 mm
Tube: 25x13 mm
Sold in pairs

sku: CH165



HANDLES INC

Square mitred

Black
Length: 600 mm
CTC: 575 mm
Tube: 25x13 mm
Sold in pairs

sku: CH166



HANDLES INC

Oval mitred

Brushed stainless steel
Length: 600 mm
CTC: 580 mm
Tube: 40x20 mm
Sold in pairs

sku: CH162



HANDLES INC

Oval mitred

Satin Brass PVD coated
Length: 600 mm
CTC: 580 mm
Tube: 40x20 mm
Sold in pairs

sku: CH090



HANDLES INC

Oval mitred

Black
Length: 600 mm
CTC: 580 mm
Tube: 40x20 mm
Sold in pairs

sku: CH164



HANDLES INC

Oval mitred

Black pvc coating
Length: 600 mm
CTC: 580 mm
Tube: 40x20 mm
Sold in pairs

sku: CH163



HANDLES INC

Offset

Brushed stainless steel
Length: 530 mm
CTC: 500 mm
Tube: 30x15 mm
Sold in pairs

sku: CH007

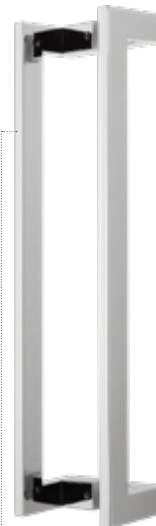

HANDLES INC

Offset

Polished stainless steel
Length: 530 mm
CTC: 500 mm
Tube: 30x15 mm
Sold in pairs

sku: CH008

pull handles



HANDLES INC
Offset
Brushed stainless steel
Length: 525 mm
CTC: 500 mm
Tube: 38x25 mm
Sold in pairs

sku: CH156



HANDLES INC
Offset
Polished stainless steel
Length: 525 mm
CTC: 500 mm
Tube: 38x25 mm
Sold in pairs

sku: CH159



HANDLES INC
Offset
Polished stainless steel
Length: 1025 mm
CTC: 1000 mm
Tube: 38x25 mm
Sold in pairs

sku: CH160



HANDLES INC
Offset
Brushed stainless steel
Length: 1025 mm
CTC: 1000 mm
Tube: 38x25 mm
Sold in pairs

sku: CH157



HANDLES INC
Offset
Polished stainless steel
Length: 1525 mm
CTC: 1500 mm
Tube: 38x25 mm
Sold in pairs

sku: CH161



HANDLES INC
Offset
Brushed stainless steel
Length: 1525 mm
CTC: 1500 mm
Tube: 38x25 mm
Sold in pairs

sku: CH158



HANDLES INC
Offset t-bar
Brushed stainless steel
Length: 400 mm
CTC: 350 mm
Tube: 25 mm
Sold in pairs

sku: CH155



HANDLES INC
Offset t-bar
Brushed stainless steel
Length: 600 mm
CTC: 500 mm
Tube: 32 mm
Sold in pairs

sku: CH154



HANDLES INC
Brushed stainless steel
Height: 300 mm
Width: 100 mm
Sold in pairs

sku: CH022

pull handles



HANDLES INC
T-bar
Ferro black
Length: 356 mm
CTC: 300 mm
Width: 100 mm
Sold in pairs

sku: CH168



HANDLES INC
Barn door style
Ferro black
Length: 203 mm
Width: 28 mm
Sold individually

sku: CH167



HANDLES INC
Barn door style
Ferro black
Length: 310 mm
Width: 55 mm
Sold individually

sku: CH170



HANDLES INC
Round
Black
Length: 420 mm
Width: 90 mm
Sold individually

sku: G11222BA



HANDLES INC
Square
Black
Length: 420 mm
Width: 70 mm
Sold individually

sku: G11224BA



HANDLES INC
Pull handle
on plate
Pewter
Length: 304 mm
Width: 63 mm
Sold individually

sku: G15263PE



HANDLES INC
Pull handle
on plate
Black
Length: 304 mm
Width: 63 mm
Sold individually

sku: G15216BA



HANDLES INC
Centre knob
Beaten pewter
Diameter: 75 mm
Sold individually

sku: G15189PE

pull handles



ORO & ORO

Pvd gold
Length: 450mm
CTC: 300mm
Sold individually

sku: L05GP



ORO & ORO

Chrome
Length: 450mm
CTC: 300mm
Sold individually

sku: L05CP



ORO & ORO

Satin chrome
Length: 450mm
CTC: 300mm
Sold individually

sku: L05SC



ORO & ORO

Matt satin nickel
Length: 450mm
CTC: 300mm
Sold individually

sku: L05SN



ORO & ORO

Titanium
Length: 450mm
CTC: 300mm
Sold individually

sku: L05TI



ORO & ORO

Black
Length: 450mm
CTC: 300mm
Sold individually

sku: L05BLK



ORO & ORO

Pvd gold
Length: 450mm
CTC: 390mm
Sold individually

sku: 106S15GP



ORO & ORO

Chrome
Length: 450mm
CTC: 390mm
Sold individually

sku: 106S15CP



ORO & ORO

Matt satin nickel
Length: 450mm
CTC: 390mm
Sold individually

sku: 106S15SN

pull handles



ORO & ORO

Pvd gold
Length: 450 mm
CTC: 390 mm
Sold individually

sku: L06GP



ORO & ORO

Chrome
Length: 450 mm
CTC: 390 mm
Sold individually

sku: L06CP



ORO & ORO

Titanium
Length: 450 mm
CTC: 390 mm
Sold individually

sku: L06TI



ORO & ORO

Pvd gold
Length: 450 mm
CTC: 420 mm
Sold individually

sku: L07GP



ORO & ORO

Chrome
Length: 450 mm
CTC: 420 mm
Sold individually

sku: L07CP



ORO & ORO

Satin nickel
Length: 450 mm
CTC: 420 mm
Sold individually

sku: L07SN



ORO & ORO

Black
Length: 450 mm
CTC: 420 mm
Sold individually

sku: L07BLK

pull handles



VALENTI
Traditional
Bronze
Length: 445 mm
CTC: 320 mm
Sold individually

sku: MT106Z.21



VALENTI
Traditional
Bronze
Length: 440 mm
CTC: 320 mm
Sold individually

sku: MT107.21



VALENTI
Traditional
Chrome
Length: 470 mm
CTC: 340 mm
Sold individually

sku: MT113



VALENTI
Traditional
Satin chrome
Length: 470 mm
CTC: 340 mm
Sold individually

sku: MT113.S.SC



VALENTI
Traditional
24k gold
Length: 448 mm
CTC: 361 mm
Sold individually

sku: MT120.07



VALENTI
Traditional
Bronze
Length: 545 mm
CTC: 410 mm
Sold individually

sku: MT125.R5.21



VALENTI
Traditional
Antique silver
Length: 545 mm
CTC: 410 mm
Sold individually

sku: MT125.R5.23



VALENTI
Traditional
Antique brass
Length: 480 mm
CTC: 392 mm
Sold individually

sku: MT129.25



VALENTI
Traditional
Dark antique brass
Length: 480 mm
CTC: 392 mm
Sold individually

sku: MT129.21

pull handles



VALENTI
Traditional
Antique brass
Length: 430 mm
CTC: 342 mm
Sold individually

sku: MT132.25



VALENTI
Traditional
Satin brass
Length: 440 mm
CTC: 350 mm
Sold individually

sku: MT139.20



VALENTI
Traditional
Bronze
Length: 440 mm
CTC: 350 mm
Sold individually

sku: MT139.21



VALENTI
Traditional
Bronze
Length: 345 mm
CTC: 275 mm
Sold individually

sku: MT253.R45.21



VALENTI
Traditional
Antique brass
Length: 533 mm
CTC: 400 mm
Sold individually

sku: MT620.21



VALENTI
Traditional
Polished brass
Length: 505 mm
CTC: 400 mm
Sold individually

sku: MT630.01



VALENTI
Traditional
Black
Length: 505 mm
CTC: 400 mm
Sold individually

sku: MT63.037

flush pull handles



HANDLES INC
Flush ring
Brushed stainless steel
Size: 63x44 mm

sku: CH0380



HANDLES INC
Flush ring
Brushed stainless steel
Size: 48x38 mm

sku: CH0381



HANDLES INC
Flush pull
Polished stainless steel
Size: 102x51 mm

sku: CH501



HANDLES INC
Flush pull
Brushed stainless steel
Size: 102x51 mm

sku: CH500



HANDLES INC
Flush pull
Ferro black
Size: 102x51 mm

sku: CH502



HANDLES INC
Flush pull
Brushed stainless steel
Size: 120x51 mm

sku: CH499



HANDLES INC
Flush pull
Black
Size: 120x51 mm

sku: CH498



HANDLES INC
Flush pull
Black
Size: 165x53 mm

sku: CH169



HANDLES INC
Mortice flush ring
Brass
Size: 70x70 mm

sku: CH516



HANDLES INC
Mortice flush ring
Brushed stainless steel
Size: 70x70 mm

sku: CH514



HANDLES INC
Mortice flush ring
Black
Size: 70x70 mm

sku: CH515



HANDLES INC
Rectangular pocket door pull
Brushed stainless steel
Size: 80x20 mm

sku: CH517

flush pull handles



HANDLES INC

Rectangular pocket
door pull

Black

Size: 80x20 mm

sku: CH556



Cabinet Handles & Knobs

cupboard handles



HANDLES INC
Bar handle
Solid brass,
satin finish
Diam: 12mm
CTC: 96mm
Length: 150mm

sku: CHBH1



HANDLES INC
Bar handle
Solid brass,
satin finish
Diam: 12mm
CTC: 128mm
Length: 180mm

sku: CHBH2



HANDLES INC
Bar handle
Solid brass,
satin finish
Diam: 12mm
CTC: 224mm
Length: 280mm

sku: CHBH5



HANDLES INC
Bar handle
Solid brass,
satin finish
Diam: 12mm
CTC: 320mm
Length: 380mm

sku: CHBH6



HANDLES INC
Bar handle
Knurled, solid
brass, satin finish
Diam: 12mm
CTC: 96mm
Length: 150mm

sku: CHBH3



HANDLES INC
Bar handle
Knurled, solid
brass, satin finish
Diam: 12mm
CTC: 128mm
Length: 180mm

sku: CHBH4



HANDLES INC
Bar handle
Knurled, solid
brass, satin finish
Diam: 12mm
CTC: 224mm
Length: 280mm

sku: CHBH83



HANDLES INC
Bar handle
Knurled, solid
brass, satin finish
Diam: 12mm
CTC: 320mm
Length: 380mm

sku: CHBH89



HANDLES INC
Bar handle
Solid brass, powder
coated black finish
Diam: 12mm
CTC: 96mm
Length: 150mm

sku: CHBH7



HANDLES INC
Bar handle
Knurled, solid
brass, powder
coated black finish
Diam: 12mm
CTC: 96mm
Length: 150mm

sku: CHBH26



HANDLES INC
Bar handle
Knurled, solid
brass, powder
coated black finish
Diam: 12mm
CTC: 280mm
Length: 224mm

sku: CHBH84



HANDLES INC
Bar handle
Knurled, solid
brass, powder
coated black finish
Diam: 12mm
CTC: 380mm
Length: 320mm

sku: CHBH90

cupboard handles



HANDLES INC
Square
mitred handle
Satin brass finish
Tube: 12x12 mm
CTC: 96 mm
Length: 108 mm

sku: CH028



HANDLES INC
Square
mitred handle
Satin brass finish
Tube: 12x12 mm
CTC: 128 mm
Length: 140 mm

sku: CH029



HANDLES INC
Square
mitred handle
Satin brass finish
Tube: 12x12 mm
CTC: 192 mm
Length: 204 mm

sku: CH030



HANDLES INC
Square
mitred handle
Satin brass finish
Tube: 12x12 mm
CTC: 256 mm
Length: 268 mm

sku: CH031



HANDLES INC
Square
mitred handle
Satin brass finish
Tube: 12x12 mm
CTC: 320 mm
Length: 332 mm

sku: CH032



HANDLES INC
Square
mitred handle
Satin brass finish
Tube: 12x12 mm
CTC: 480 mm
Length: 492 mm

sku: CH033



HANDLES INC
Square
mitred handle
Black finish
Tube: 12x12 mm
CTC: 96 mm
Length: 108 mm

sku: CHBH27



HANDLES INC
Square
mitred handle
Black finish
Tube: 12x12 mm
CTC: 128 mm
Length: 140 mm

sku: CHBH28



HANDLES INC
Square
mitred handle
Black finish
Tube: 12x12 mm
CTC: 192 mm
Length: 204 mm

sku: CHBH29



HANDLES INC
Square
mitred handle
Black finish
Tube: 12x12 mm
CTC: 256 mm
Length: 268 mm

sku: CHBH30



HANDLES INC
Square
mitred handle
Black finish
Tube: 12x12 mm
CTC: 320 mm
Length: 332 mm

sku: CHBH31



HANDLES INC
Square
mitred handle
Black finish
Tube: 12x12 mm
CTC: 480 mm
Length: 492 mm

sku: CHBH32

cupboard handles



HANDLES INC
Square
mitred handle
Satin nickel finish
Size: 8x8 mm
CTC: 96 mm

sku: CHBH8



HANDLES INC
Square
mitred handle
Satin nickel finish
Size: 8x8 mm
CTC: 128 mm

sku: CHBH11



HANDLES INC
Square
mitred handle
Black finish
Size: 8x8 mm
CTC: 96 mm

sku: CHBH10



HANDLES INC
Square
mitred handle
Black finish
Size: 8x8 mm
CTC: 128 mm

sku: CHBH13



HANDLES INC
Barcelona handle
Satin nickel finish
CTC: 96 mm
Length: 115 mm

sku: CHBH41



HANDLES INC
Barcelona handle
Satin nickel finish
CTC: 128 mm
Length: 154 mm

sku: CHBH44



HANDLES INC
Barcelona handle
Satin nickel finish
CTC: 160 mm
Length: 192 mm

sku: CHBH47



HANDLES INC
Barcelona handle
Satin nickel finish
CTC: 192 mm
Length: 225 mm

sku: CHBH50



HANDLES INC
Barcelona handle
Satin nickel finish
CTC: 256 mm
Length: 288 mm

sku: CHBH53



HANDLES INC
Barcelona handle
Satin nickel finish
CTC: 320 mm
Length: 360 mm

sku: CHBH56



HANDLES INC
Barcelona handle
Black finish
CTC: 96 mm
Length: 115 mm

sku: CHBH43



HANDLES INC
Barcelona handle
Black finish
CTC: 128 mm
Length: 154 mm

sku: CHBH46

cupboard handles



HANDLES INC
Barcelona handle
Black finish
CTC: 160 mm
Length: 192 mm

sku: CHBH49



HANDLES INC
Barcelona handle
Black finish
CTC: 192 mm
Length: 225 mm

sku: CHBH52



HANDLES INC
Barcelona handle
Black finish
CTC: 256 mm
Length: 288 mm

sku: CHBH55



HANDLES INC
Barcelona handle
Black finish
CTC: 320 mm
Length: 360 mm

sku: CHBH58



HANDLES INC
Traditional handle
Antique brass finish
CTC: 96 mm
Length: 110 mm

sku: CHBH67



HANDLES INC
Traditional handle
Antique brass finish
CTC: 128 mm
Length: 142 mm

sku: CHBH69



HANDLES INC
Traditional handle
Antique silver finish
CTC: 96 mm
Length: 110 mm

sku: CHBH66



HANDLES INC
Traditional handle
Antique silver finish
CTC: 128 mm
Length: 142 mm

sku: CHBH68



HANDLES INC
Traditional handle
Polished
chrome finish
CTC: 160 mm
Length: 175 mm

sku: CHBH33



HANDLES INC
Traditional handle
Black finish
CTC: 160 mm
Length: 175 mm

sku: CHBH34



HANDLES INC
Traditional handle
Antique silver finish
CTC: 160 mm
Length: 175 mm

sku: CHBH35



HANDLES INC
Traditional handle
Antique brass finish
CTC: 160 mm
Length: 175 mm

sku: CHBH36

cupboard handles



HANDLES INC
Traditional handle
Polished
chrome finish
CTC: 256 mm
Length: 270 mm

sku: CHBH37



HANDLES INC
Traditional handle
Black finish
CTC: 256 mm
Length: 270 mm

sku: CHBH38



HANDLES INC
Traditional handle
Antique silver finish
CTC: 256 mm
Length: 270 mm

sku: CHBH39



HANDLES INC
Traditional handle
Antique brass finish
CTC: 256 mm
Length: 270 mm

sku: CHBH40



HANDLES INC
Traditional handle
Polished
chrome finish
CTC: 128 mm
Length: 148 mm

sku: CHBH70



HANDLES INC
Traditional handle
Black finish
CTC: 128 mm
Length: 148 mm

sku: CHBH71



HANDLES INC
Traditional handle
Antique silver finish
CTC: 128 mm
Length: 148 mm

sku: CHBH72



HANDLES INC
Traditional handle
Antique brass finish
CTC: 128 mm
Length: 148 mm

sku: CHBH73



HANDLES INC
Traditional handle
Polished
chrome finish
CTC: 192 mm
Length: 212 mm

sku: CHBH74



HANDLES INC
Traditional handle
Black finish
CTC: 192 mm
Length: 212 mm

sku: CHBH75



HANDLES INC
Traditional handle
Antique silver finish
CTC: 192 mm
Length: 212 mm

sku: CHBH76



HANDLES INC
Track set kit
Antique brass finish
CTC: 192 mm
Length: 212 mm

sku: CHBH77

cupboard handles



HANDLES INC
Traditional handle
Polished chrome finish
CTC: 224 mm
Length: 252 mm

sku: CHBH78



HANDLES INC
Traditional handle
Black finish
CTC: 224 mm
Length: 252 mm

sku: CHBH79



HANDLES INC
Traditional handle
Antique silver finish
CTC: 224 mm
Length: 252 mm

sku: CHBH80



HANDLES INC
Traditional handle
Antique brass finish
CTC: 224 mm
Length: 252 mm

sku: CHBH81

HANDLES INC
Half moon handle
Satin brass finish
CTC: 64 mm
Length: 90 mm
Width: 45 mm



sku: CHBH82

HANDLES INC
Half moon handle
Stainless steel
CTC: 64 mm
Length: 90 mm
Width: 45 mm



sku: CHBH93

HANDLES INC
Half moon handle
Black stainless steel
CTC: 64 mm
Length: 90 mm
Width: 45 mm



sku: CHBH92

HANDLES INC
Cup handle
Zamak satin brass finish
CTC: 76 mm
Length: 96 mm



sku: CHBK41

HANDLES INC
Cup handle
Solid brass satin finish
CTC: 76 mm
Length: 96 mm



sku: CHBK70

HANDLES INC
Cup handle
Satin nickel finish
CTC: 76 mm
Length: 96 mm



sku: CHBK40

HANDLES INC
Cup handle
Black finish
CTC: 76 mm
Length: 96 mm



sku: CHBK42

HANDLES INC
Cup handle
Polished chrome finish
CTC: 64 mm
Length: 94 mm



sku: CHBH59

cupboard handles

HANDLES INC

Cup handle
Black finish
CTC: 64 mm
Length: 94 mm



sku: CHBH60

HANDLES INC

Cup handle
Antique silver finish
CTC: 64 mm
Length: 94 mm



sku: CHBH61

HANDLES INC

Cup handle
Antique brass finish
CTC: 64 mm
Length: 94 mm



sku: CHBH62

HANDLES INC

Back plate
for handle
Satin brass finish
Size: 19x219 mm
CTC: 128 mm



sku: CHBH16

HANDLES INC

Back plate
for handle
Satin brass finish
Size: 19x420 mm
CTC: 320 mm



sku: CHBH15

HANDLES INC

Knurled T handle
on plate
Satin brass finish
Size: 19x219 mm
CTC: 128 mm



sku: CH1604

HANDLES INC

Square handle
on plate
Satin brass finish
Size: 19x219 mm
CTC: 128 mm



sku: CH1629

HANDLES INC

T handle on plate
Satin brass finish
Size: 19x219 mm
CTC: 128 mm



sku: CH1602

HANDLES INC

Knurled T
handle plate
Satin brass finish
Size: 19x420 mm
CTC: 320 mm



sku: CH1589

HANDLES INC

Square handle
on plate
Satin brass finish
Size: 19x420 mm
CTC: 320 mm



sku: CH1532

HANDLES INC

T handle on plate
Satin brass finish
Size: 19x420 mm
CTC: 320 mm



sku: CH1506

HANDLES INC

Half moon handle
Natural wood finish
CTC: 64 mm
Length: 100 mm



sku: BIRCHPLZ1

cupboard handles



Half moon handle
Black wood finish
CTC: 64 mm
Length: 100 mm

sku: BIRCHPLZ2



Half moon handle
Natural wood finish
CTC: 96 mm
Length: 140 mm

sku: BIRCHPLZ3



Half moon handle
Black wood finish
CTC: 96 mm
Length: 140 mm

sku: BIRCHPLZ4



Half moon handle
Natural wood finish
CTC: 160 mm
Length: 200 mm

sku: BIRCHPLZ5



Half moon handle
Black wood finish
CTC: 160 mm
Length: 200 mm

sku: BIRCHPLZ6



D handle
Natural wood finish
CTC: 96 mm
Length: 120 mm

sku: BIRCHPLZ7



D handle
Black wood finish
CTC: 96 mm
Length: 120 mm

sku: BIRCHPLZ8



D handle
Natural wood finish
CTC: 192 mm
Length: 212 mm

sku: BIRCHPLZ9



D handle
Black wood finish
CTC: 192 mm
Length: 212 mm

sku: BIRCHPLZ10



D handle
Natural wood finish
CTC: 256 mm
Length: 275 mm

sku: BIRCHPLZ11



D handle
Black wood finish
CTC: 256 mm
Length: 275 mm

sku: BIRCHPLZ12



D handle
Natural wood finish
CTC: 160 mm
Length: 200 mm

sku: BIRCHPLZ13

cupboard handles



D handle
Black wood finish
CTC: 160 mm
Length: 200 mm

sku: BIRCHPLZ14



D handle
Natural wood finish
CTC: 320 mm
Length: 360 mm















sku: BIRCHPLZ15



D handle
Black wood finish
CTC: 320 mm
Length: 360 mm

sku: BIRCHPLZ16

cupboard knobs

 <p>HANDLES INC Round knob Satin brass finish Diam: 28 mm Height: 20 mm</p> <p>sku: CHBK2</p>	 <p>HANDLES INC Round knob Black finish Diam: 28 mm Height: 20 mm</p> <p>sku: CHBK16</p>	 <p>HANDLES INC Round knob Satin brass finish Diam: 29 mm Height: 24 mm</p> <p>sku: CHBK33</p>
 <p>HANDLES INC Round knob Black finish Diam: 29 mm Height: 24 mm</p> <p>sku: CHBK34</p>	 <p>HANDLES INC Round knob Satin nickel finish Diam: 29 mm Height: 24 mm</p> <p>sku: CHBK32</p>	 <p>HANDLES INC Round knob Satin brass finish Diam: 40 mm Height: 20 mm</p> <p>sku: CHBK53</p>
 <p>HANDLES INC Round knob Black finish Diam: 40 mm Height: 20 mm</p> <p>sku: CHBK54</p>	 <p>HANDLES INC Cabinet Knob Antique brass Width: 34 mm Height: 26 mm</p> <p>sku: CHBK65</p>	 <p>HANDLES INC Cabinet Knob Antique silver Width: 34 mm Height: 26 mm</p> <p>sku: CHBK64</p>
 <p>HANDLES INC Cabinet Knob Black finish Width: 34 mm Height: 26 mm</p> <p>sku: CHBK63</p>	 <p>HANDLES INC Cone knob Satin brass finish Diam: 22 mm Height: 25 mm</p> <p>sku: CHBK1</p>	 <p>HANDLES INC Cone knob Black finish Diam: 22 mm Height: 25 mm</p> <p>sku: CHBK15</p>
 <p>HANDLES INC Concave knob Satin brass finish Diam: 35 mm Height: 27 mm</p> <p>sku: CHBK36</p>	 <p>HANDLES INC Concave knob Satin nickel finish Diam: 35 mm Height: 27 mm</p> <p>sku: CHBK35</p>	 <p>HANDLES INC Concave knob Black finish Diam: 35 mm Height: 27 mm</p> <p>sku: CHBK37</p>

cupboard knobs



HANDLES INC
Round knob
Satin brass finish
Diam: 35 mm
Height: 30 mm

sku: CHBK67



HANDLES INC
Round knob
Satin nickel finish
Diam: 35 mm
Height: 30 mm

sku: CHBK69



HANDLES INC
Round knob
Black finish
Diam: 35 mm
Height: 30 mm

sku: CHBK68



HANDLES INC
Square knob
Satin brass finish
Length: 30 mm
Breadth: 30 mm
Height: 20 mm

sku: CHBK44



HANDLES INC
Square knob
Black finish
Length: 30 mm
Breadth: 30 mm
Height: 20 mm

sku: CHBK45



HANDLES INC
Square knob
Satin nickel finish
Length: 30 mm
Breadth: 30 mm
Height: 20 mm

sku: CHBK43



HANDLES INC
Knurled round knob
Satin nickel finish
Diam: 32 mm
Height: 32 mm

sku: CHBK47



HANDLES INC
Knurled round knob
Black finish
Diam: 32 mm
Height: 32 mm

sku: CHBK48



HANDLES INC
T-knob
Knurled, brass
Diam: 12 mm
Depth: 32 mm
Length: 50 mm

sku: CHBK6



HANDLES INC
T-knob
Satin brass finish
Diam: 12 mm
Depth: 32 mm
Length: 50 mm

sku: CHBK4



HANDLES INC
T-knob
Knurled, black finish
Diam: 12 mm
Depth: 32 mm
Length: 50 mm

sku: CHBK39



HANDLES INC
T-knob
Black finish
Diam: 12 mm
Depth: 32 mm
Length: 50 mm

sku: CHBK18



HANDLES INC
Knurled pull knob
Satin brass finish
Diam: 25 mm
Height: 28 mm
Height: mm

sku: CHBK46



HANDLES INC
Knurled pull knob
Black finish
Diam: 25 mm
Height: 28 mm
Height: mm

sku: CHBK49



HANDLES INC
Pull knob
Satin brass finish
Diam: 20 mm
Height: 25 mm

sku: CHBK3

cupboard knobs



HANDLES INC
Pull knob
Black finish
Diam: 20 mm
Height: 25 mm

sku: CHBK17



HANDLES INC
Pull knob
Knurled, brass
Diam: 14 mm
Height: 25 mm

sku: CHBK5



HANDLES INC
Pull knob
Knurled, black finish
Diam: 14 mm
Height: 25 mm

sku: CHBK19



HANDLES INC
Drop pendant
Satin brass finish
Height: 78 mm

sku: CHBK9



HANDLES INC
Drop ring
Satin brass finish
Width: 31 mm
Height: 50 mm

sku: CHBK8



HANDLES INC
Drop ring
Satin brass finish
Width: 36 mm
Height: 50 mm

sku: CHBK7



HANDLES INC
Hex knob
Satin brass finish
Diam: 35 mm
Height: 20 mm

sku: CHBK14



HANDLES INC
Back plate for knob
Satin brass finish
Diam: 28 mm

sku: CHBH14



HANDLES INC
Back plate for knob
Satin brass finish
Size: 19x130 mm

sku: CHBH17



HANDLES INC
Knurled knob on plate
Satin brass finish
Diam: 28 mm

sku: CH1405



HANDLES INC
Knurled knob on plate
Satin brass finish
Diam: 28 mm

sku: CH1403



HANDLES INC
Concave knob on plate
Satin brass finish
Diam: 28 mm

sku: CH1436



HANDLES INC
Knurled T knob on plate
Satin brass finish
Diam: 28 mm

sku: CH1406



HANDLES INC
T knob on plate
Satin brass finish
Diam: 28 mm

sku: CH1404



HANDLES INC
Knurled knob on plate
Satin brass finish
Size: 19x130 mm

sku: CH1705

cupboard knobs



HANDLES INC
Kr knob on plate
Satin brass finish
Size:
19x130 mm

sku: CH1703



HANDLES INC
Concave knob
on plate
Satin brass finish
Size:
19x130 mm

sku: CH1736



HANDLES INC
Knurled T knob
on plate
Satin brass finish
Size:
19x130 mm

sku: CH1706



HANDLES INC
T knob on plate
Satin brass finish
Size:
19x130 mm

sku: CH1704



HANDLES INC
Round knob
Birch 5% White
Diam: 50 mm

sku: BIRCHPLZ21



HANDLES INC
Round knob
Birch black
Diam: 50 mm

sku: BIRCHPLZ22



HANDLES INC
Round knob
Birch 5% White
Diam: 70 mm

sku: BIRCHPLZ23



HANDLES INC
Round knob
Birch black
Diam: 70 mm

sku: BIRCHPLZ24



HANDLES INC
Square knob
Birch 5% White
Size: 50x50 mm

sku: BIRCHPLZ17



HANDLES INC
Square knob
Birch black
Size: 50x50 mm

sku: BIRCHPLZ18



HANDLES INC
Square knob
Birch 5% White
Size: 70x70 mm

sku: BIRCHPLZ19



HANDLES INC
Square knob
Birch black
Size: 70x70 mm

sku: BIRCHPLZ20

door stops



HANDLES INC
Magnetic, floor mounted
door stop
Satin nickel finish

sku: CH005



HANDLES INC
Magnetic, floor mounted
door stop
Polished chrome finish

sku: CH062



HANDLES INC
Magnetic, floor mounted
door stop
Polished brass finish

sku: CH061



HANDLES INC
Magnetic, floor mounted
door stop
Black

sku: CH077



HANDLES INC
Magnetic, floor mounted
door stop
Antique brass finish

sku: CH060



HANDLES INC
Magnetic, floor mounted
door stop
Satin chrome finish

sku: CH253



HANDLES INC
Magnetic, floor mounted
door stop
Polished chrome finish

sku: CH255



HANDLES INC
Magnetic, floor mounted
door stop
Black

sku: CH254



HANDLES INC
Magnetic, wall or floor
mounted door stop
Satin nickel finish

sku: CH024



HANDLES INC
Magnetic, wall or floor
mounted door stop
Polished chrome finish

sku: CH059



HANDLES INC
Magnetic, wall or floor
mounted door stop
Polished brass finish

sku: CH058



HANDLES INC
Magnetic, wall or floor
mounted door stop
Black

sku: CH023

door stops



HANDLES INC
Magnetic, wall or floor
mounted door stop
Antique brass finish

sku: CH057



HANDLES INC
Half moon, floor mounted
door stop
Polished chrome finish

sku: CH065



HANDLES INC
Half moon, floor mounted
door stop
Polished brass finish

sku: CH064



HANDLES INC
Half moon, floor mounted
door stop
Brushed stainless steel

sku: CH066



HANDLES INC
Half moon, floor mounted
door stop
Black

sku: CH252



HANDLES INC
Half moon, floor mounted
door stop
Antique brass finish

sku: CH063



HANDLES INC
Floor mounted door stop
Brushed stainless steel

sku: CH027



HANDLES INC
Floor mounted door stop
Brushed stainless steel

sku: CH040



HANDLES INC
Floor mounted door stop
Brushed stainless steel

sku: CH0400



HANDLES INC
Floor mounted door stop
Black

sku: CH250



HANDLES INC
Wall mounted door stop
Stainless steel

sku: CH257



HANDLES INC
Wall mounted door stop
Satin brass

sku: CH258

door stops



HANDLES INC
Wall mounted door stop
Black

sku: CH259



Hinges

hinges



HANDLES INC
Double
action hinge
Pvd brass
Size: 100 mm

sku: CH044



HANDLES INC
Double
action hinge
Pvd brass
Size: 150 mm

sku: CH045



HANDLES INC
Double
action hinge
Stainless steel
Size: 106 mm

sku: CH082



HANDLES INC
Double
action hinge
Stainless steel
Size: 127 mm

sku: CH083



HANDLES INC
Double
action hinge
Stainless steel
Size: 152 mm

sku: CH084



HANDLES INC
3D concealed
hinge 120kg
Silver
Size:
195x35x34 mm

sku: CH542



HANDLES INC
3D concealed
hinge 120kg
Black
Size:
195x35x34 mm

sku: CH543



HANDLES INC
3D concealed
hinge 100kg
Silver
Size:
165x32x32 mm

sku: CH541



HANDLES INC
3D concealed
hinge 100kg
Black
Size:
165x32x32 mm

sku: CH540



HANDLES INC
3D concealed
hinge 60kg
Silver
Size:
140x30x24 mm

sku: CH539



HANDLES INC
3D concealed
hinge 60kg
Black
Size:
140x30x24 mm

sku: CH538



HANDLES INC
Concealed hinge
Satin nickel
Size: 117x25 mm

sku: CH507



HANDLES INC
Concealed hinge
Black
Size: 117x25 mm

sku: CH506



HANDLES INC
Concealed hinge
Satin nickel
Size: 95x19 mm

sku: CH508



HANDLES INC
Concealed hinge
Black
Size: 95x19 mm

sku: CH509

hinges



HANDLES INC
Concealed hinge
Satin nickel
Size: 60x13mm

sku: CH519



HANDLES INC
Concealed hinge
Black
Size: 60x13mm

sku: CH518



HANDLES INC
Concealed hinge
Satin nickel
Size: 45x13mm

sku: CH521



HANDLES INC
Concealed hinge
Black
Size: 45x13mm

sku: CH522



HANDLES INC
Ball bearing hinge
Satin brass
Size: 100x75mm

sku: CH544



HANDLES INC
Ball bearing hinge
Stainless steel
Size: 100x75mm

sku: CH523



HANDLES INC
Ball bearing hinge
Stainless steel black
Size: 100x75mm

sku: CH524



HANDLES INC
Two ball bearing hinge
Stainless steel
Size: 75x50mm

sku: CH527



JUSTOR
Single action spring hinge
Stainless steel
Size: 120mm

sku: 5314.05



JUSTOR
Single action spring hinge
Natural anodised aluminium
Size: 120mm

sku: 5314.01



JUSTOR
Single action spring hinge
Black
Size: 120mm

sku: 5314.09



JUSTOR
Single action spring hinge
Pvd brass
Size: 180mm

sku: 5814.04



JUSTOR
Single action spring hinge
Stainless steel
Size: 180mm

sku: 5814.05



JUSTOR
Single action spring hinge
Natural anodised aluminium
Size: 180mm

sku: 5814.01



JUSTOR
Single action spring hinge
Black
Size: 180mm

sku: 5814.09

hinges



JUSTOR
Single action
sinkless
spring hinge
Stainless steel
Size: 150x40 mm

sku: 6314.05



JUSTOR
Single action
sinkless
spring hinge
Natural anodised
aluminium
Size: 150x40 mm

sku: 6314.01



JUSTOR
Single action
sinkless
spring hinge
Black
Size: 150x40 mm

sku: 6314.09



JUSTOR
Double action
spring hinge
Stainless steel
Size: 180x40 mm

sku: 5914.05



JUSTOR
Double action
spring hinge
Natural anodised
aluminium
Size: 180x40 mm

sku: 5914.01



JUSTOR
Double action
spring hinge
Gold
Size: 180x40 mm

sku: 5914.02



JUSTOR
Double action
spring hinge
Black
Size: 180x40 mm

sku: 5914.09



JUSTOR
Double action
spring hinge
Natural anodised
aluminium
Size: 180x50 mm

sku: 5934.01



JUSTOR
Weld-on
spring hinge
Mild steel
Size: 120 mm
For fire doors

sku: PG120



JUSTOR
Weld-on
spring hinge
Mild steel
Size: 240 mm
For fire doors

sku: PP240



Locks & Cylinders

locks and cylinders



HANDLES INC

50mm backset double throw
latch lock
304 grade face and striker plate
CH196 Brass

Included:



HANDLES INC

50mm backset double throw
latch lock
304 grade face and striker plate
CH197 Stainless steel

Included:



HANDLES INC

50mm backset double throw
latch lock
304 grade face and striker plate
CH198 Black

Included:



HANDLES INC

50mm backset double throw
roller lock
304 grade face and striker plate
CH192 Stainless steel



HANDLES INC

50mm backset double throw
roller lock
304 grade face and striker plate
CH193 Black



HANDLES INC

60mm backset double throw
roller lock
304 grade face and striker plate
CH194 Stainless steel



HANDLES INC

60mm backset double throw
roller lock
304 grade face and striker plate
CH195 Black



HANDLES INC

Privacy dead lock
CH048 Brushed stainless steel

Included:



locks and cylinders



HANDLES INC
Tubular latch
IB3709LKNP Satin nickel



HANDLES INC
Lever dead lock
D033B Brass
D033S Stainless steel

Included:



HANDLES INC
57mm lever sash lock
D034BRS Brass
D034S Stainless steel

Included:



HANDLES INC
57mm heavy duty 3 lever
Close gate levers for anti-pick.
20mm throw. 100 key differs.
5276300 Brass
5276320 Stainless steel

Included:



HANDLES INC
57mm 5 lever sash lock
Heavy duty. 20mm long throw. 500
key differs.
527650020 Polished Brass
5276500 Stainless steel

Included:



HANDLES INC
57mm 3 lever sash lock
DPS3BRS Brass
DPS3 Satin Nickel
DPS3BLK Black



HANDLES INC
61mm cylinder sash lock
DPS6157B Brass
DPS6157 Satin Nickel
DPS6157BLK Black



HANDLES INC
Bathroom sash lock
D035B Brass
D035S Stainless steel

Included:



locks and cylinders

HANDLES INC

Cylinder dead lock
D037BRS Brass
D037S Stainless steel

Included:



HANDLES INC

61mm cylinder sash lock
D036BRS Brass
D036S Stainless steel
D036BLK Black

Included:



HANDLES INC

57mm heavy duty cylinder lock
Robust construction, suitable for
large oval cylinder 15mm throw.
5522000 Brass
5522020 Stainless steel



HANDLES INC

85mm double throw roller lock
5212050 Brass
521205012 Satin Nickel
5212050BLK Black



HANDLES INC

85mm double throw latch lock
52110 Brass
521105012 Satin Nickel
5211050BLK Black



HANDLES INC

Double throw cylinder dead lock
52310 Brass
523105012 Nickel plated
5231050BLK Black



HANDLES INC

Double throw 3 point lock
Concealed top and bottom rods.
53131 Satin Brass
5313112 Satin Nickel



HANDLES INC

Double throw 5 point lock
Concealed top and bottom rods.
53137 Satin Brass
5313712 Satin Nickel



locks and cylinders



HANDLES INC

Cylinder hook lock
45110 Brass
451105012 Nickel plated



HANDLES INC

Rebate kit for 61mm cylinder locks
D039BR Brass plated
D039SS Satin nickel
D039BLK Black



HANDLES INC

Rebate kit for lever locks
D038BR Brass plated
D038SS Satin nickel



HANDLES INC

Rebate kit for 85mm latch locks
521RB Brass
521RB12 Satin Nickel
521RBBLK Black



HANDLES INC

Rebate kit for 85mm roller lock
523RB Brass
523RB12 Satin Nickel
523RBBLK Black



HANDLES INC

Rebate kit for hook lock
451RB Brass
451RB12 Nickel plated
451RBBLK Black



HANDLES INC

Double Cylinder
6 pin biting system. Brass body and plugs. 140 000 key combinations. KD, KA, MK, GMK. Available sizes: 60-120mm. Finishes: brass, satin nickel, black, antique brass.
Double Cylinder



HANDLES INC

Knob Cylinder
6 pin biting system. Brass body and plugs. 140 000 key combinations. KD, KA, MK, GMK. Available sizes: 60-120mm. Finishes: brass, satin nickel, black, antique brass.
Knob Cylinder

locks and cylinders



HANDLES INC

WC Cylinder

Available sizes: 62mm to 69mm.
Finishes: brass, satin nickel, black and antique brass.

Privacy Cylinder



HANDLES INC

Half Cylinder

6 pin biting system. Brass body and plugs. 140 000 key combinations. KD, KA, MK, GMK. Available sizes: 60-120mm. Finishes: brass, satin nickel, black, antique brass.

Half Cylinder



HANDLES INC

Half Knob Cylinder

Available sizes: 44-95mm.
Finishes: brass, satin nickel, black, antique brass.

Half Knob Cylinder



HANDLES INC

Square privacy set

50x50mm. 8mm spindle. Male/Female fixing.

CH025 Brushed stainless steel



HANDLES INC

Round privacy set

48mm diameter. 8mm spindle. Male/Female fixing.

CH026 Brushed stainless steel



HANDLES INC

Round privacy set

48mm diameter. 8mm spindle. Male/Female fixing.

CH350 Black



Door Accessories

accessories



HANDLES INC
Adjustable heavy duty
roller catch
Brushed stainless steel

sku: CH039



HANDLES INC
Adjustable heavy duty
roller catch
Satin brass

sku: CH040



HANDLES INC
Adjustable heavy duty
roller catch
Black

sku: CH041



HANDLES INC
Neodymium extra
strong magnet set
Chrome
Diam: 22 mm

sku: CH038



HANDLES INC
Letter flap
Polished stainless steel
WxH: 300x75 mm

sku: CH042



HANDLES INC
Letter flap
Brushed stainless steel
WxH: 300x75 mm

sku: CH043



JUSTOR
Internal screen
door closer
Natural anodised
aluminium
Max: 20kg door

sku: 5613.01



JUSTOR
External screen
door closer
Black
Max: 20kg door

sku: 5613.09



HANDLES INC
Cabin hook
Brushed stainless steel
Size: 150 mm

sku: CH504



HANDLES INC
Cabin hook
Brushed stainless steel
Size: 200 mm

sku: CH537

accessories

HANDLES INC

Cabin hook

Powdercoated black
stainless steel

Size: 150 mm



sku: CH505

HANDLES INC

Cabin hook

Powdercoated black
stainless steel

Size: 200 mm



sku: CH536

HANDLES INC

Barn door privacy latch

Stainless steel

Size: 87x70



sku: CH200

HANDLES INC

Barn door privacy latch

Ferro black

Size: 87x70



sku: CH199

HANDLES INC

Gothic gate latch

Black



sku: GI1151BA

HANDLES INC

Barrel bolt straight

Stainless steel

Length: 80 mm



sku: CH068

HANDLES INC

Barrel bolt straight

Stainless steel

Length: 100 mm



sku: CH071

HANDLES INC

Barrel bolt straight

Stainless steel

Length: 150 mm



sku: CH070

HANDLES INC

Barrel bolt necked

Stainless steel

Length: 80 mm



sku: CH067

HANDLES INC

Barrel bolt necked

Stainless steel

Length: 150 mm



sku: CH069

accessories



HANDLES INC
Shephard crook bolt
straight
Pewter
Length: 110 mm

sku: GI5119PE



HANDLES INC
Shephard crook bolt
necked
Pewter
Length: 110 mm

sku: GI5120PE



HANDLES INC
Shephard crook bolt
straight
Pewter
Length: 170 mm

sku: GI5121PE



HANDLES INC
Shephard crook bolt
necked
Pewter
Length: 170 mm

sku: GI5122PE



HANDLES INC
Bag clip
Stainless steel

sku: CH503



BHABNA
Barrel bolt
Antique brass
Length: 250 mm

sku: 1531/AB/250



BHABNA
Barrel bolt
Antique brass
Length: 500 mm

sku: 1531/AB/500



BHABNA
Barrel bolt
Oil rubbed bronze
Length: 250 mm

sku: 1531/AS/250



BHABNA
Barrel bolt
Oil rubbed bronze
Length: 500 mm

sku: 1531/AS/500



BHABNA
Barrel bolt
Polished chrome
Length: 250 mm

sku: 1531/CP/250

accessories



BHABNA
Barrel bolt
Polished chrome
Length: 500 mm

sku: 1531/CP/500



BHABNA
Barrel bolt
Polished brass
Length: 250 mm

sku: 1531/PB/250



BHABNA
Barrel bolt
Polished brass
Length: 500 mm

sku: 1531/PB/500



BHABNA
Barrel bolt
Satin chrome
Length: 250 mm

sku: 1531/SC/250



BHABNA
Barrel bolt
Satin chrome
Length: 500 mm

sku: 1531/SC/500



HANDLES INC
Flush bolt
Satin brass
Length: 150 mm

sku: CHFB150SB



HANDLES INC
Flush bolt
Satin brass
Length: 200 mm

sku: CHFB200SB



HANDLES INC
Flush bolt
Satin brass
Length: 300 mm

sku: CHFB300SB



HANDLES INC
Flush bolt
Brushed stainless steel
Length: 150 mm

sku: CHFB150SS



HANDLES INC
Flush bolt
Brushed stainless steel
Length: 200 mm

sku: CHFB200SS

accessories



HANDLES INC
Flush bolt
Brushed stainless steel
Length: 300 mm

sku: CHF300SS



HANDLES INC
Flush bolt
Black
Length: 150 mm

sku: CHF150MB



HANDLES INC
Flush bolt
Black
Length: 200 mm

sku: CHF200MB



HANDLES INC
Flush bolt
Black
Length: 300 mm

sku: CHF300MB

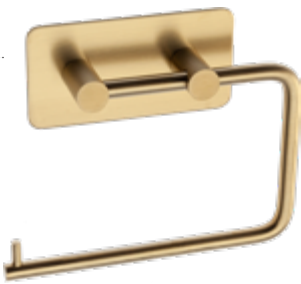

HANDLES INC
Toilet roll holder
Satin brass
Size: 92x47 mm

sku: HKTP4



HANDLES INC
Toilet roll holder
White
Size: 92x47 mm

sku: HKTP5



HANDLES INC
Toilet roll holder
Polished chrome
Size: 92x47 mm

sku: HKTP2



HANDLES INC
Toilet roll holder
Stainless steel
Size: 92x47 mm

sku: HKTR1



HANDLES INC
Toilet roll holder
Black
Size: 92x47 mm

sku: HKTP3



HANDLES INC
Escutcheon plate
Satin nickel
Size: 60x45 mm

sku: CH079

accessories



HANDLES INC
Escutcheon plate
Black
Size: 60x45 mm

sku: CH078

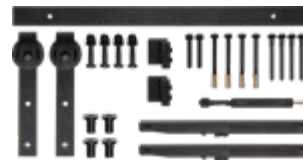

HANDLES INC
Barn door track set
Ferro black
Size: 2000 mm

sku: CH525

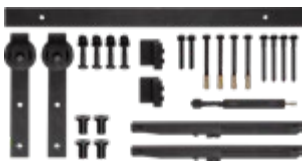

HANDLES INC
Barn door track set
Ferro black
Size: 2500 mm

sku: CH526

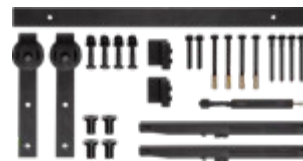

HANDLES INC
Barn door track set
Ferro black
Size: 3000 mm

sku: CH555



HANDLES INC
Track set adjustable guide
Ferro black

sku: CH525-GUIDE



HANDLES INC
Track set kit
Ferro black

sku: CH525-KIT



HANDLES INC
Door guard
Satin nickel

sku: CH533



HANDLES INC
Door guard
Black

sku: CH534



HANDLES INC
Door guard
Satin brass

sku: CH535

hooks



HANDLES INC
Single round self adhesive hook
White
Diam: 48 mm

sku: HK1015W



HANDLES INC
Single round self adhesive hook
Satin brass
Diam: 48 mm

sku: HK1015BRS



HANDLES INC
Single round self adhesive hook
Polished stainless steel
Diam: 48 mm

sku: HK1015P



HANDLES INC
Single round self adhesive hook
Brushed stainless steel
Diam: 48 mm

sku: HK1015S



HANDLES INC
Single round self adhesive hook
Black
Diam: 48 mm

sku: HK1015B



HANDLES INC
Single square self adhesive hook
White
Size: 47x47 mm

sku: HK1016W



HANDLES INC
Single square self adhesive hook
Satin brass
Size: 47x47 mm

sku: HK1016BRS



HANDLES INC
Single square self adhesive hook
Polished stainless steel
Size: 47x47 mm

sku: HK1016P



HANDLES INC
Single square self adhesive hook
Brushed stainless steel
Size: 47x47 mm

sku: HK1016S



HANDLES INC
Single square self adhesive hook
Black
Size: 47x47 mm

sku: HK1016B



HANDLES INC
Double square self adhesive hook
White
Size: 92x47 mm

sku: HK1017W



HANDLES INC
Double square self adhesive hook
Satin brass
Size: 92x47 mm

sku: HK1017BRS



HANDLES INC
Double square self adhesive hook
Polished stainless steel
Size: 92x47 mm

sku: HK1017P



HANDLES INC
Double square self adhesive hook
Brushed stainless steel
Size: 92x47 mm

sku: HK1017S



HANDLES INC
Double square self adhesive hook
Black
Size: 92x47 mm

sku: HK1017B

hooks



HANDLES INC
Quadruple self adhesive hook
White
Size: 182x47 mm

sku: HK1018W



HANDLES INC
Quadruple self adhesive hook
Satin brass
Size: 182x47 mm

sku: HK1018BRS



HANDLES INC
Quadruple self adhesive hook
Polished stainless steel
Size: 182x47 mm

sku: HK1018P



HANDLES INC
Quadruple self adhesive hook
Brushed stainless steel
Size: 182x47 mm

sku: HK1018S



HANDLES INC
Quadruple self adhesive hook
Black
Size: 182x47 mm

sku: HK1018B



HANDLES INC
Hat and coat hook
Pewter
Size: 150 mm

sku: GI5150PE



HANDLES INC
Hat and coat hook
Black
Size: 150 mm

sku: GI5150BA



HANDLES INC
Robe hook
Pewter
Size: 80 mm

sku: GI5156PE



HANDLES INC
Robe hook
Black
Size: 150 mm

sku: GI5156BA



HANDLES INC
Fleur hook
Pewter
Size: 120 mm

sku: GI5127PE



HANDLES INC
Gothic hook
Pewter
Size: 120 mm

sku: GI5126PE



HANDLES INC
Single hook
Black
Size: 95 mm

sku: GI5555BA



Fritsjurgens Door Pivots

Fritsjurgens

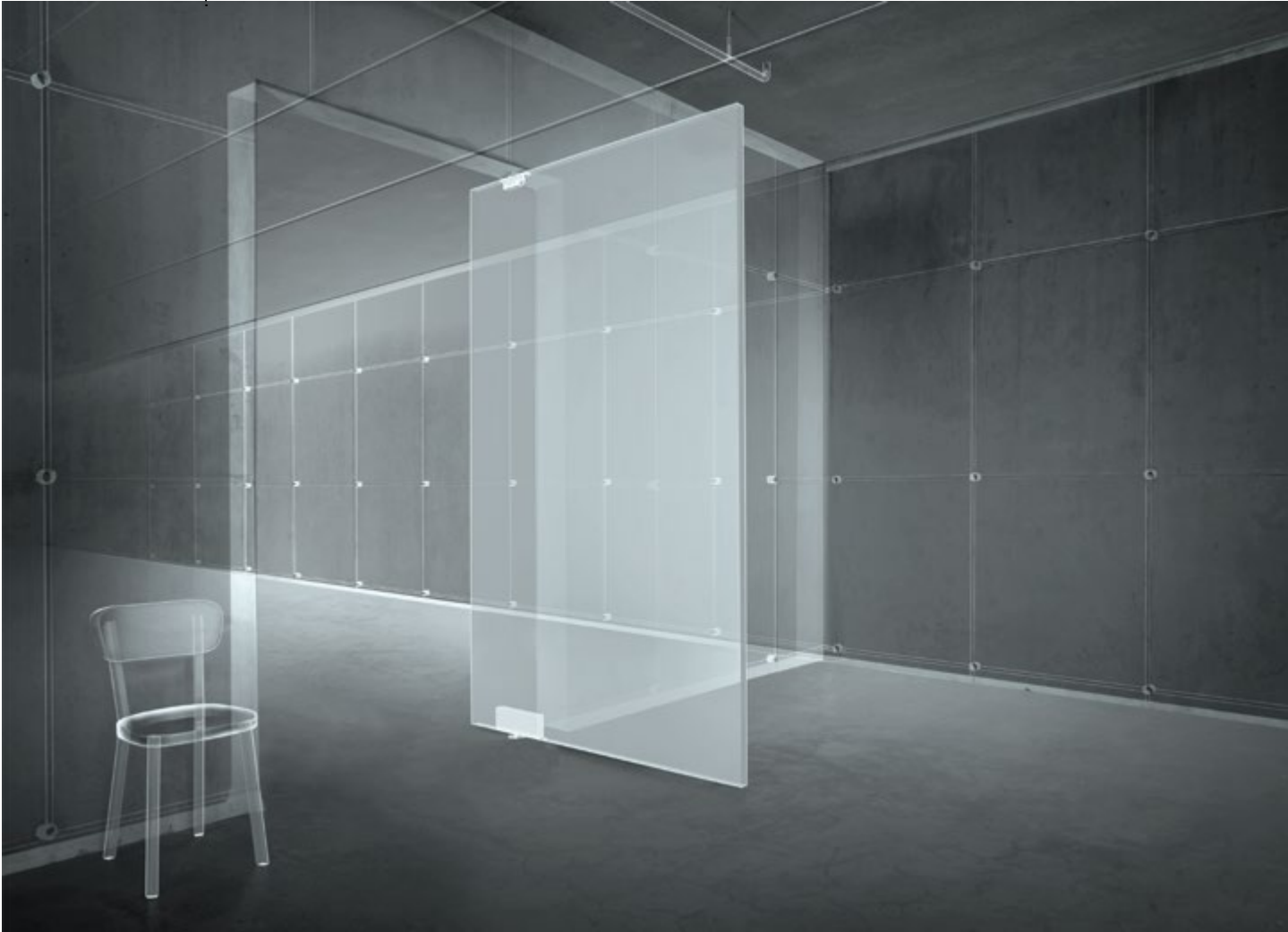

Every FritsJurgens pivot hinge offers the architect the possibility to design pivot doors without limitations. The high load-bearing capacity of the hinges gives freedom to create pivot doors that exceed the function of a normal door and become true design statements. From frameless subtle doors to true eye catchers or even hidden bookcases, FritsJurgens pivot hinges make it possible for architects to bring their visions to life.

The System M hinge is virtually indestructible. Built from high performance materials, the system is maintenance-free. Our rigorous testing has shown that even after 1 million cycles (similar to 136 years of daily use) System M still behaves flawlessly. System M packs the highest corrosion resistance. Even the most diverse conditions do not affect the operation of this system. System M packs an enormous amount of force into a compact space. To harness this power we have developed a casing out of a monolithic piece of aluminium. We have also made the camshafts out of tempered steel for ultimate endurance. This is a system truly designed for the ages: invisible, built-to-last and maintenance-free.

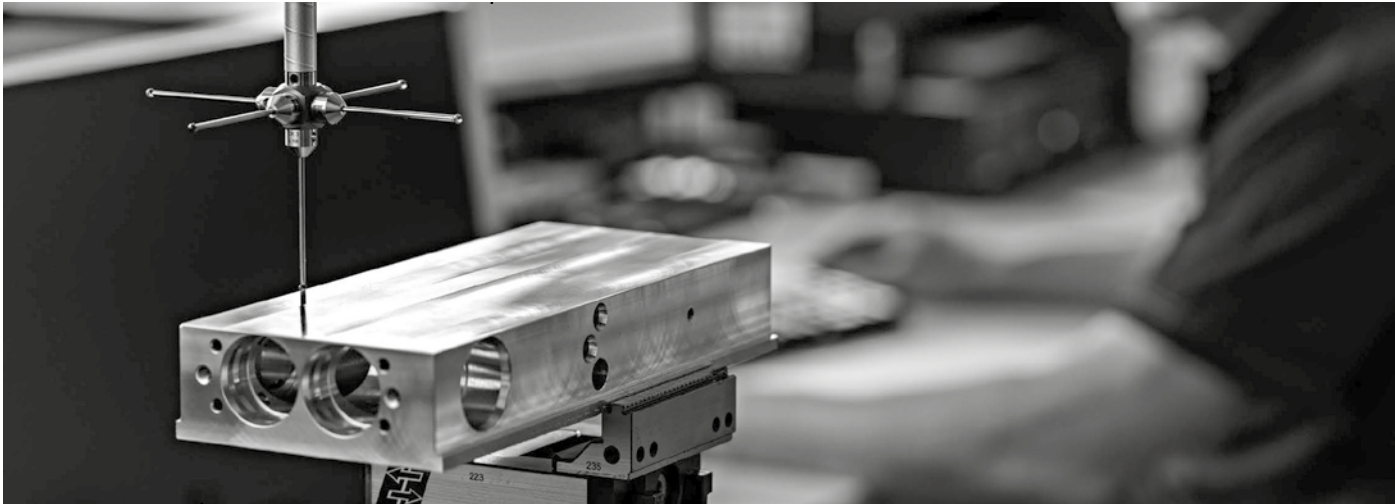

The System M adds a new dimension to the pivot door by creating the ultimate smoothness: total control over the movement of the door.



- Hold positions at 0°, 90° and -90°
- Self-closing from -125° and 125° - After opening, the door returns smoothly to the 0° position. The door can be manually set to the hold position 90° or -90°.
- Adjustable closing damping (soft close)
- Adjustable hydraulic back check
- No structural elements in the floor or ceiling
- Quick and simple to install
- Maintenance-free
- For new construction and retrofit situations
- Easily adjustable
- Timber, steel, massive and aluminium doors
- Steel and timber framed glass doors
- Single and double-acting pivot doors
- Interior and exterior doors
- Commercial and residential

No structural elements in Floor and ceiling

The revolution FritsJurgens® brings to the idea of a pivot door is that all the closer technology is fully-mortised in the top and bottom of the door, so that only floor and ceiling plates need to be installed. A virtually invisible system.

The bottom hinge of System M and its floorplate have been completely re-engineered from the ground up to deliver a state-of-the-art closer in the smallest profile possible for just about any door. The system can be combined with existing FritsJurgens® top pivots.

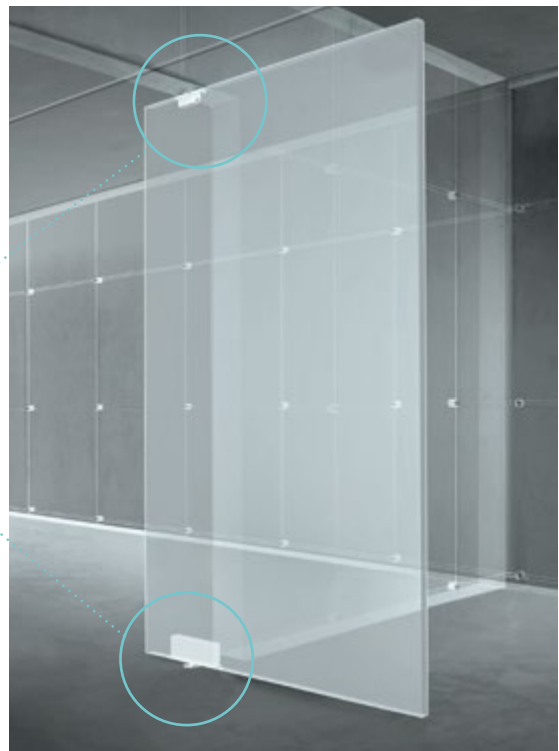

Systems features



SYSTEM ONE

SYSTEM 3

SYSTEM M

	SYSTEM ONE	SYSTEM 3	SYSTEM M
Rotation	360°	360°	-125° to 125°
System dimensions	160 x 34 x 39 mm	160 x 34 x 143 mm	294,8 x 32 x 99,6 mm
System weight	0,335 kg	0,75 kg	2,6 kg
Hold positions at every 90°	✗	✓	✗
Hold positions at 90° and -90°	✗	✗	✓
Self-opening	✗	✓	✗
Self-closing	✗	✓	✓
Adjustable closing damping (soft-close)	✗	✗	✓
Adjustable hydraulic back check	✗	✗	✓
Suitable for single action doors	✓	✗	✓
Suitable for double action doors	✓	✓	✓
Minimal number of movements tested	1.000.000	1.000.000	1.000.000
Minimum door thickness	40mm	40mm	40mm
Load-bearing capacity (up to)	500 kg	500 kg	500 kg
Maximum weight at latch force	NA	350 kg	300 kg

Overview systems

The FritsJurgens® pivot door range consists of three systems.



System One is the most compact system: the hinge acts as a revolving point.

SKU: 60010/b11

Movement

- Rotates 360°
- No hold positions or closing function

Positioning

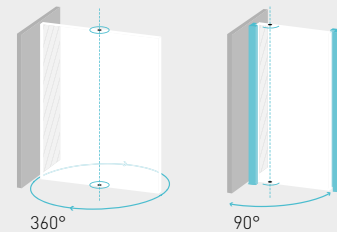

System 3 has three functions: rotation, closing and hold positions. System 3 can turn through 360° and is characterized by a hold position at every quarter of a circle.

SKU: 600128/b11

Movement

- Rotates 360°
- Hold positions at 0°, 90°, 180° and 270°
- Self-opening - The door automatically moves from each 45° angle in both directions to the next hold position
- Self-closing - The door comes to rest in the desired hold position after a few movements

Positioning

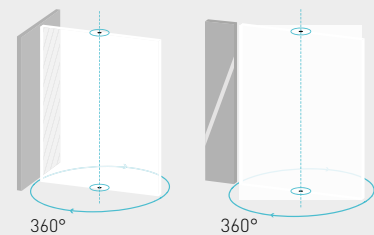

System M adds a new dimension to the pivot door by creating the ultimate smoothness: total control over the movement of the door.

Movement

- Hold positions at 0°, 90° and -90°
- Self-closing from -125° and 125° - After opening, the door returns smoothly to the 0° position. The door can be manually set to the hold position 90° or -90°.
- Adjustable closing damping (soft close)
- Adjustable hydraulic back check

Positioning

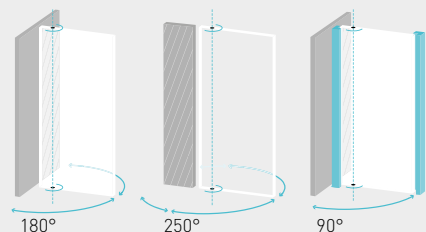



Drop Down Seals

CCE – Automatic drop down seals



Automatic drop-down seals for doors are created to close the annoying gap between the door and the floor. Filling the gap when the door is closed, automatic seals keep out dust and insects and protect from air, water, wind and noise to guarantee comfort and safety in living spaces. CCE offers a wide range of products with particular performances to fit any application.

TREND

A basic model, small in its dimensions, available with many different combinations of seals and plungers. Despite its simplicity this product can guarantee great acoustic performances, from 32 dB to 39 dB noise reduction depending on the type of seal

size 12x20 mm

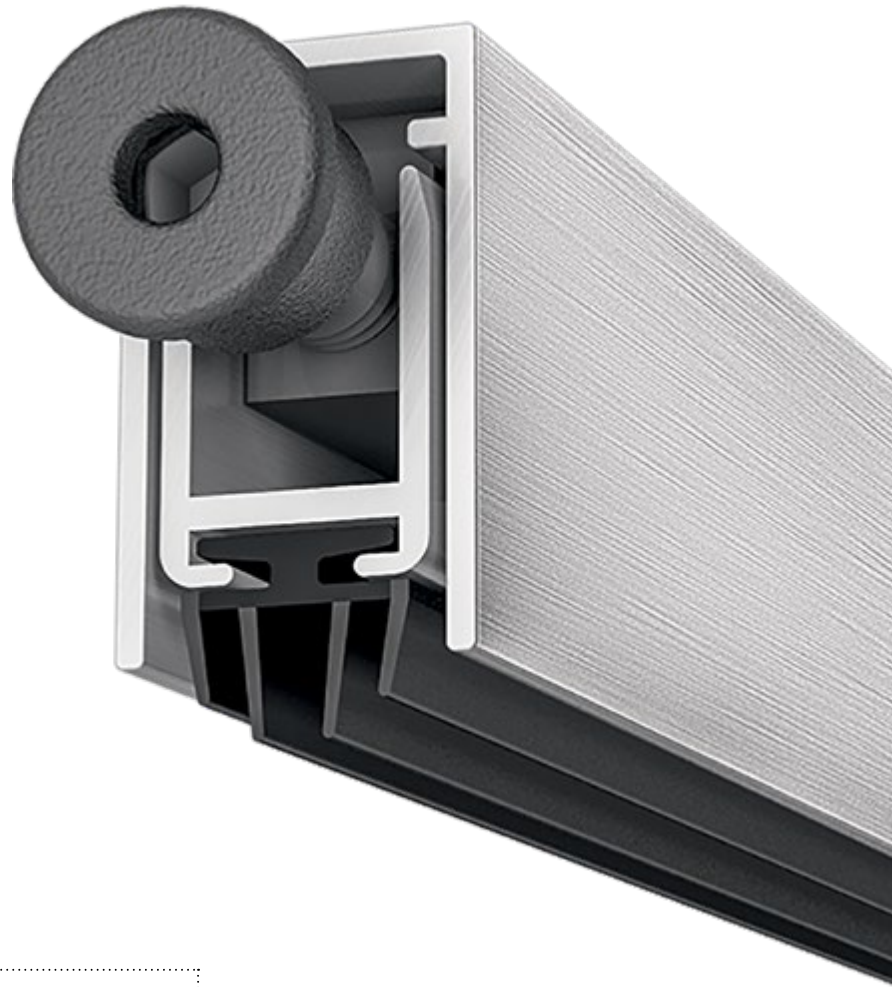
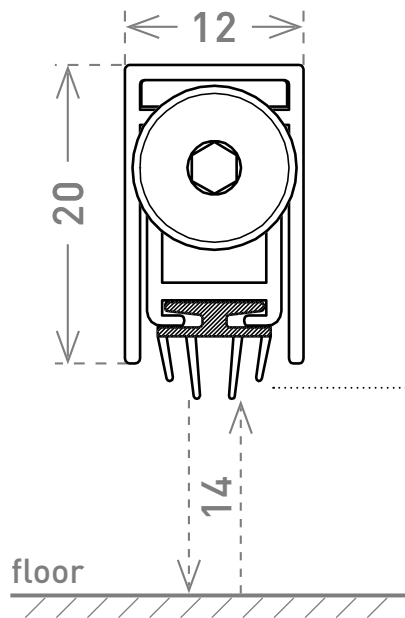

Door Application

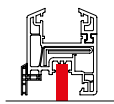
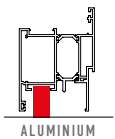

Lengths

- 730
- 830
- 930
- 1030
- 1130
- 1230

Seals

A



THERM

32 dB Rw

IFT Cert. n.
PB-G03-04
en-01_PB22

B



SIL

37 dB Rw

IFT Cert. n.
PB-G03-04
en-01_PB20

C



THERM

39 dB Rw

IFT Cert. n.
PB-G03-04
en-01_PB19

D



PP

CON GUARNIZIONE

One of the all-time CCE classics, available with many different combination of seals and plungers, it guarantees a high efficiency. Its mechanism can be pulled out from both hinge and lock sides (CCE patent). This model can be installed also on pivoting doors in combination with Actuator Pivot accessory.



size 11,7x30 mm

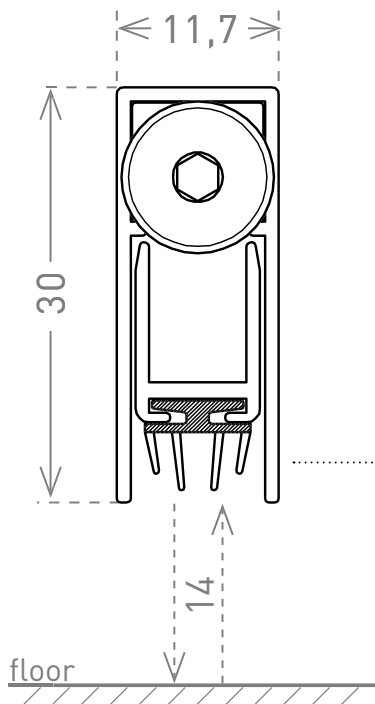

Door Application

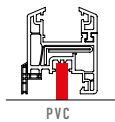

Lengths

- 730
- 830
- 930
- 1030
- 1130
- 1230

Seals

A



THERM

39 dB Rw
IFT Cert. n.
PB-G03-04
en-01_PB10

B



SIL

44 dB Rw
IFT Cert. n.
PB-G03-04
en-01_PB11

C



THERM

39 dB Rw
IFT Cert. n.
PB-G03-04
en-01_PB12

D



PP

ALU PLUS

A small acoustic seal with a 46 dB noise reduction performance (IFT Rosenheim certificate). It can be used with the Doppio Pulsante accessory to ensure the maximum sealing. This product can be installed also on pivoting doors in combination with Actuator Pivot accessory.

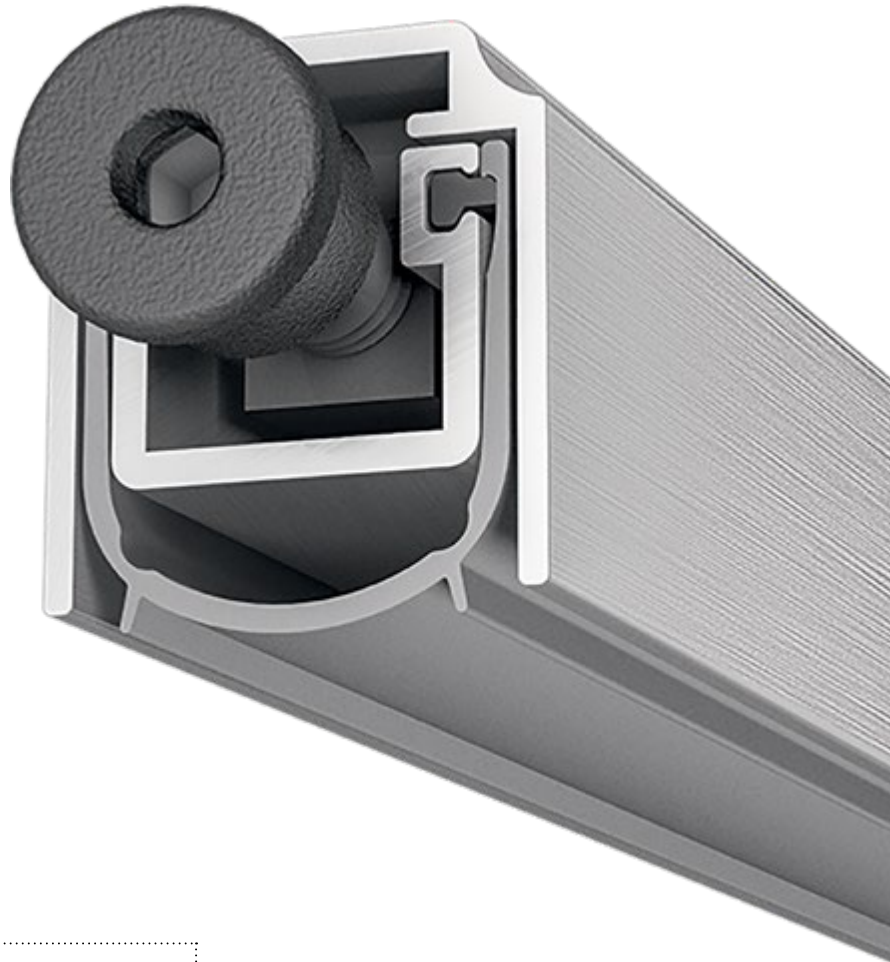

size 16,6x18 mm

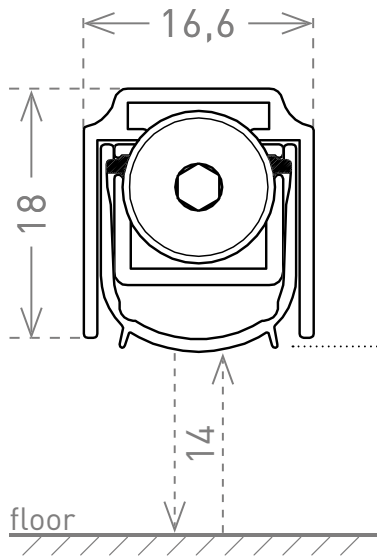

Door Application

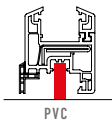
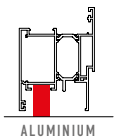

Lengths

- 730
- 830
- 930
- 1030
- 1130
- 1230

Seals

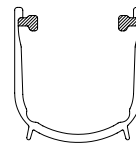

THERM

46 dB Rw

IFT Cert. n.
167 38273/Z12e



DROP 20 MINI

A top range product, fire resistant up to 60 minutes (certified), with 50dB of noise reduction, 20 mm of maximum drop and three different fixing systems. This model can be combined with the Doppio Pulsante accessory to ensure the maximum sealing and it can be installed also on pivoting doors in combination with Actuator Pivot accessory.

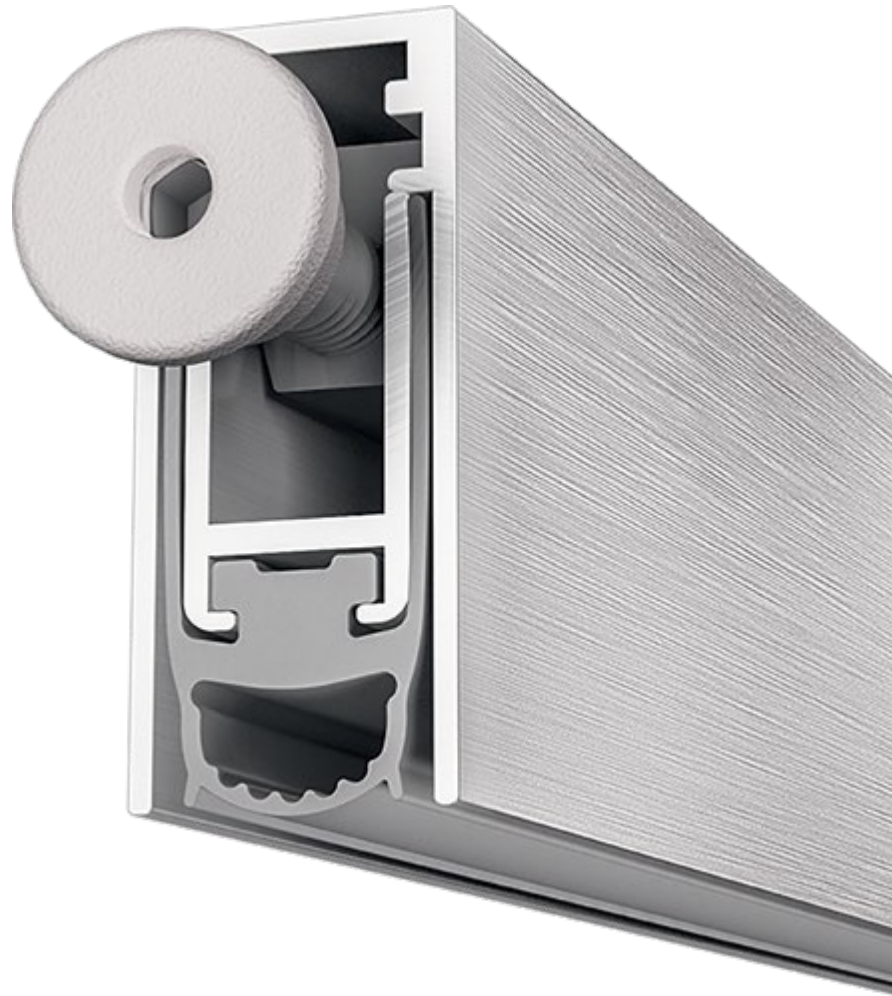

size 13x30 mm

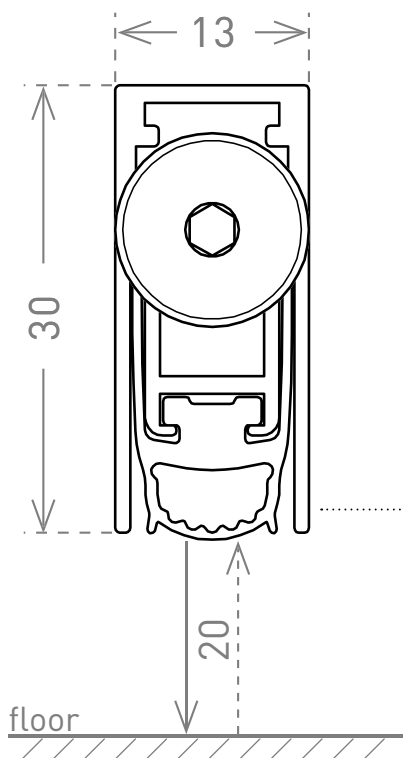

Door Application

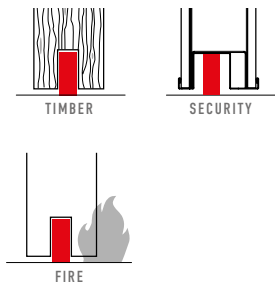

Lengths

- 730
- 830
- 930
- 1030
- 1130
- 1230



Seals

HF2

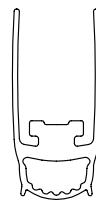

SIL

50
dB Rw

IFT Cert. n.
PB Z05-G03
04-en-01
PB09



60 min.

CFR Cert. n.
CFR1604131



cULUS
LISTED

UL 10C
File nrR39141

DROP 20 MAXI

A top range product, fire resistant up to 60 minutes (certified), with 52dB of noise reduction, 20 mm of maximum drop and three different fixing systems. Available with a profile of 28 mm or 30 mm height, this product can be combined with a wide range of accessories, for both two leafs doors and pivoting doors.

size 15x28 mm size 15x30 mm

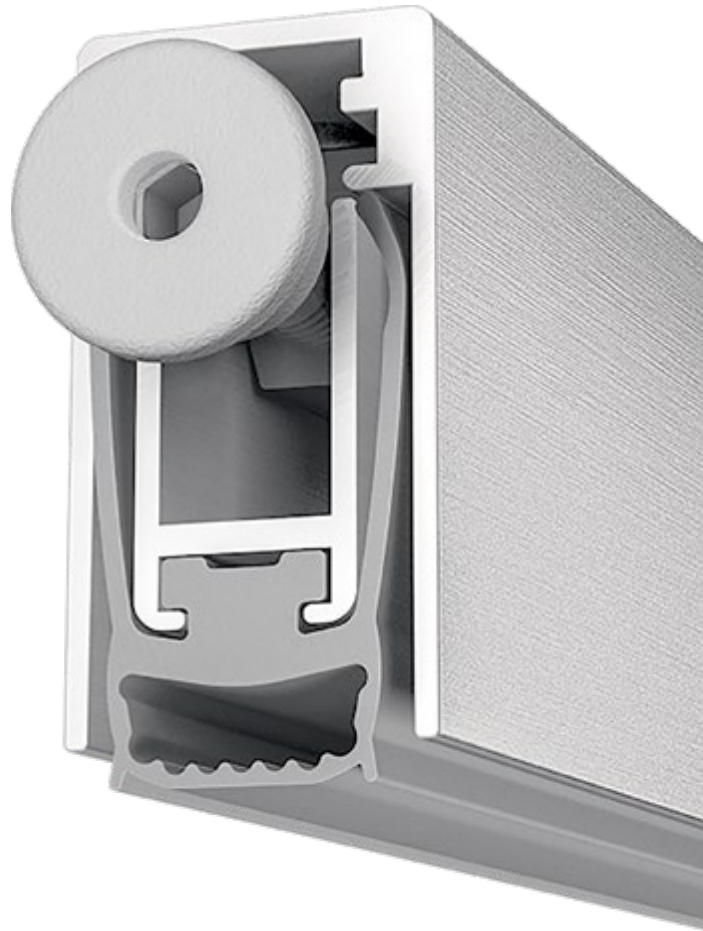
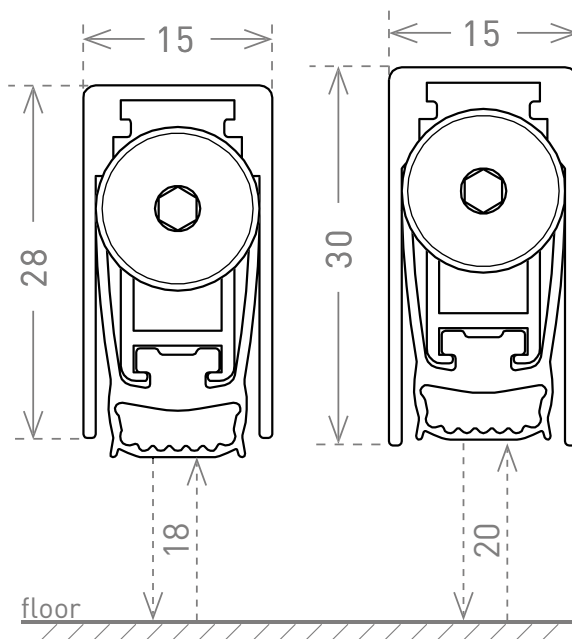

Door Application

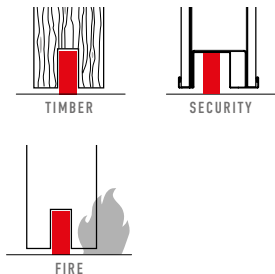

Lengths

- 730
- 830
- 930
- 1030
- 1130
- 1230

Seals

HF3

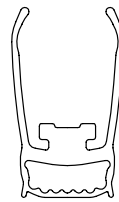

52
dB Rw

IFT Cert. n.
PB Z03-G03-
04-en-01
PB04

SIL



60 min.

CFR Cert. n.
CFR1605191



cULUS
LISTED

UL 10C
File nrR39141

drop down seals



CCE

Automatic drop down seal

PVC & timber doors
11,7x30 mm
39 dB Rw

Various lengths

sku: ASGSFI



CCE

Automatic drop down seal

PVC, aluminium & timber doors
12x20 mm
39 dB Rw

Various lengths

sku: ASTD



CCE

Automatic drop down seal

Security & fire doors
12x29 mm
50 dB Rw

IFT Rosenheim certificate

Various lengths

sku: ASDRO



CCE

Automatic drop down seal

Aluminium & PVC doors
16,6x18 mm
46 dB Rw

IFT Rosenheim certificate

Various lengths

sku: ASPAL



CCE

Automatic drop down seal

Timber, pivot & fire doors
13x30 mm
50 dB Rw

Certified 60min fire resistant

Various lengths

sku: ASDRO60M

Finishes

Galvanic finishes

The handle is protected by a layer of chrome. Galvanisation of the brass handle gives it a protective metal coat of nickel-chromium to guard against wear and corrosion.

PVD Finishes

With physical vapour deposition, a polished or satin-finish chrome handle is coated with an ulterior layer of metal (superfinishing) under high vacuum. Vacuum metallisation is extremely hard and durable. Nano composites of metal determine the specific colour of the surface and protect it from wear, scratches and aggressive substances such as humidity, sweat, salt spray, temperature swings and ultraviolet rays.

Superfinish®

Superfinish is a new technological finishing cycle patented by Olivari after having developed and perfected it in its factories. It consists of depositing metal composites, with special features, on brass in titrated alloy.



Olivari guarantee

Guarantee period

The guarantee period changes according to the finish type and begins on the day of purchase by the first end-user:

SuperGold bright and satin: guaranteed for 30 years.

SuperNickel bright and satin: guaranteed for 30 years.

SuperSainlessSteel satin: guaranteed for 30 years.

SuperCopper satin: guaranteed for 10 years.

SuperBronze satin: guaranteed for 10 years.

SuperAnthracite satin: guaranteed for 10 years.

Guarantee exceptions

Not covered by guarantee is damage caused by:

- not following assembling instructions
- not following maintenance instructions or using cleaning products not recommended
- blunt and/or sharp objects
- improper use and use not consistent with normal use of the product.

Guarantee conditions

The guarantee covers only the first purchasing end-user and is valid for the period described above.

Complaints must be made at the headquarters of the store where purchase was made. After the complaint has been accepted by Olivari s.p.a. technicians the guarantee covers the purchaser for, alternatively, free repair of the product, substitution of the same, or refund of the maximum amount of the price on the purchase receipt for said product. The guarantee is not extendable, and, therefore, Olivari s.p.a. is not responsible for refunding any costs for shipping and/or delivery, disassembly and/or re-assembly of the product. Furthermore, no other damage will be reimbursed even if due to product non compliance.





Warranty Statement

HANGLES INC provides the following warranty in relation to its products:

Warranty against defects in the materials and workmanship of the Product – 1 year from the date of installation / delivery unless specifically covered by the manufacturer for a longer period.

The warranty is subject to the following conditions:

1. The purchaser acknowledges that the products are not indestructible, and that some care in installation and maintenance is necessary. The warranty therefore excludes any damage caused by misuse or failure to adhere to the manufacturers installation specifications and guidelines or other cause other than defective materials or workmanship.
2. Any claim for warranty must be made, by contacting HANGLES INC at the address listed above, at the earliest stage that the defect becomes obvious to enable prompt action and to avoid further damage, and must be made no later than 1 month from the defect/date of repair becoming obvious.
3. If a defect covered by warranty appears before the end of the Warranty Period, then HANGLES INC will, in its sole discretion, either:
 - a. replace or repair the Product or defective part of the Product free of charge; or
 - b. refund the price of the product; or
 - c. re-supply the defective labour and workmanship; or
 - d. refund the price of the labour and workmanship.
4. Products presented for repair may be replaced by refurbished goods of the same type rather than being repaired. Refurbished parts may be used to repair the Products.
5. Any claim for warranty must be accompanied by appropriate documentation which stipulates the date of the installation, the invoice number, the customer name and address and the alleged defect.
6. The customer must make the product or workmanship available to HANGLES INC for inspection and testing. If HANGLES INC finds no fault in the Product or its workmanship, then the customer must pay HANGLES INC usual costs of service work, inspection and testing.
7. Warranty work will be conducted by HANGLES INC during normal working hours (8.00am to 4.30pm Monday to Friday).
8. No liability is accepted for, and this warranty does not apply to:
 - a. fair wear and tear;
 - b. defects arising due to installation of the Products where the Products were not installed by HANGLES INC suggested agents;
 - c. any damage caused to the structures the Products are installed in, where the products were not installed by HANGLES INC suggested agents.
- d. damage caused by circumstances beyond HANGLES INC control.
- e. products that have been used other than for the purpose for which they were designed;
- f. defects that arise due to abuse, misuse or neglect;
- g. damage caused by exposure to abnormal conditions including but not limited to environment, temperature, water, fire, humidity, pressure, stress or similar;
- h. products that have been modified, built on or repaired;
- i. products that have not been maintained as recommended by HANGLES INC;
- j. maintenance items (which are the responsibility of the customer);
- k. products installed, maintained or operated other than in accordance with HANGLES INC instructions; and
- l. overhaul, replacement or repair works undertaken prior to approval from HANGLES INC of any warranty claim.
9. HANGLES INC makes no express warranties or representations other than set out in this warranty.
10. HANGLES INC reserves the right to alter product specifications at any time.

www.handlesinc.co.za